



## Jeep Grand Cherokee WL 2022-on and Jeep Grand Cherokee L 2021-on Predator Front Bar

### **IMPORTANT! – READ BEFORE INSTALLATION**



- When installed in accordance with these instructions, the front protection bar does not affect the operation of the vehicles SRS airbags.
- This product must be installed exactly as per these instructions using only hardware supplied.
- Take a few moments to read instructions thoroughly before beginning work.
- In the event of damage to any bar component please contact OFFROAD ANIMAL to arrange repair/replacement of components.
- Do not use this product for any vehicle make or model other than that specified on these instructions.
- Do not remove labels from this product.
- This product and its fixings must not be modified in any way unless stated in these fitting instructions.
- The installation of this product is recommended for trained personnel.
- These instructions are correct at time of publication. OFFROAD ANIMAL cannot be held responsible for the impact of any changes subsequently made by the vehicle manufacturer. If you find something has changed, please contact us to let us know!
- During installation it is the duty of the installer to check correct operation/clearances of all components.
- If Instructions are to be printed for reference in the workshop, it is recommended that they are printed in colour, for best legibility.

# PARTS LISTING

**IMPORTANT:** Check all parts are present before beginning work! Contact OFFROAD ANIMAL if something is missing.

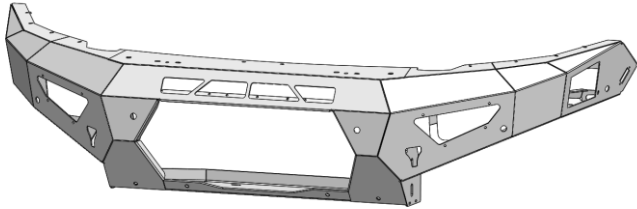
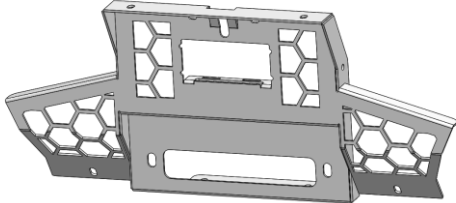
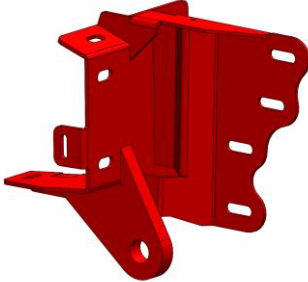
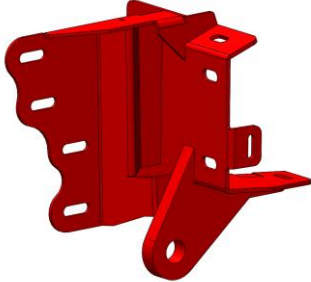

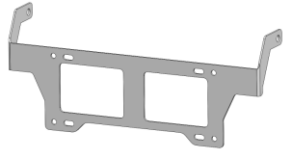
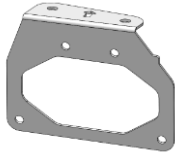
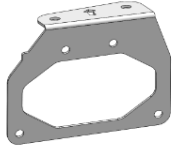
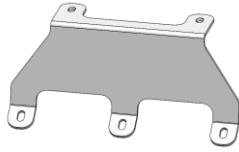
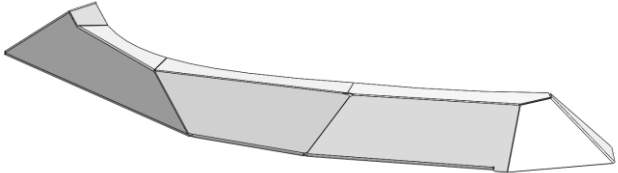
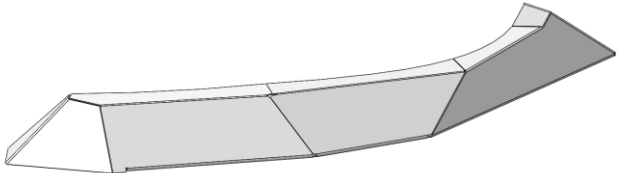

## Main Parts – In the Box

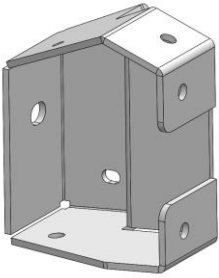
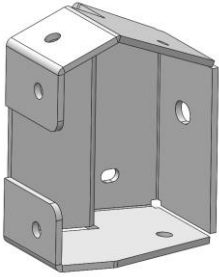
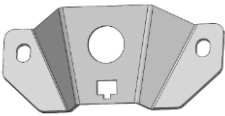
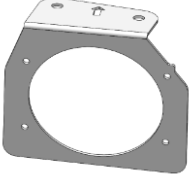
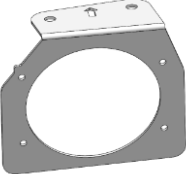
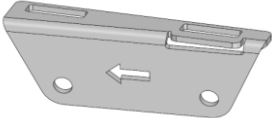
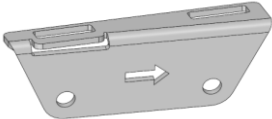
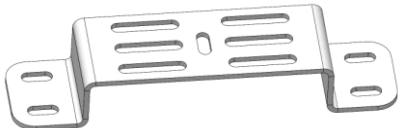



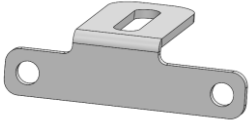
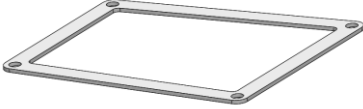
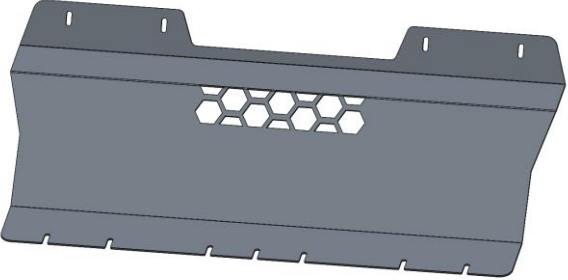
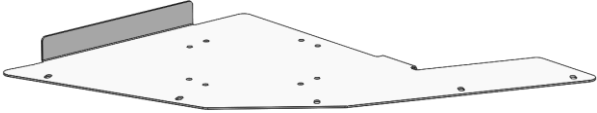

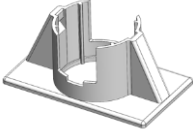
Qty	Part Number	Description	Image
1	FB-JGC-WL-22-PR-ASM1	WL Predator Bar Welded Assembly	
1	FB-JGC-WL-22-PR-ASM2	WL Mesh Fairlead Assy	
1	FB-JGC-WL-22-PR-ASM3R	WL Impact Assembly RH	
1	FB-JGC-WL-22-PR-ASM3L	WL Impact Assembly LH	

1	M-0002R	Light Cover Mesh	
1	M-0002L	Light Cover Mesh	
1	B-0821	WL ACC Radar Bracket	
1	B-0822	WL Predator Number Plate Bracket	
<b>Suitable for Overland/Trailhawk models</b>			
1	B-0827R	WL Predator Fog Light Bracket	
1	B-0827L	WL Predator Fog Light Bracket	
1	B-0829	WL Predator Pan Brace	
1	B-0830R	WL Predator Headlight Infill Panel	
1	B-0830L	WL Predator Headlight Infill Panel	

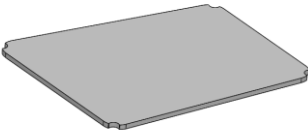
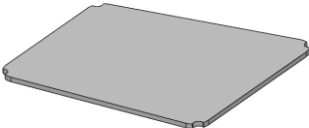
1	B-0833R	WL Predator Front Mount Chassis Brace	
1	B-0833L	WL Predator Front Mount Chassis Brace	
1	B-0835	WL Predator Camera Relocation Bracket	
<b>Suitable for Night Eagle/Laredo/Altitude/Limited/Summit/Summit Reserve models</b>			
1	B-0880R	WL Predator Halo Fog Bracket	
1	B-0880L	WL Predator Halo Fog Bracket	
1	B-0881R	WL Predator Side Radar Bracket	
1	B-0881L	WL Predator Side Radar Bracket	
1	B-0882	WL Winch Control Box Relocation Bracket	



1	B-1074	WL Predator 4xe Pedestrian Speaker Bracket	
2	P-0283	WL Predator Side Radar Cover Mount Plate	
1	U-0062	WL Predator Bash Plate	
1	U-0063R	WL Predator Side Underpanel	
1	U-0063L	WL Predator Side Underpanel	
1	7922AM2	LED AutoLamps 7922 Amber Side Marker Twin Pack	
6	F-0015	Chevrolet/Jeep Sensor Holder – Straight	
1	N-0007	WL ACC Radar Cover Panel	

1	N-0008R	WL Side Radar Cover Panel	
1	N-0008L	WL Side Radar Cover Panel	
1	FB-JGC-WL-22-PR-ADRCP	ADR Compliance Plate WL Grand Cherokee	
1	OFA-LOGO	Offroad Animal Metal Logo	
1	TK-COM-PSEN-6	Tape Kit - 6 Sensor Universal	
1	TK-FB-THL-N80-15	Tape Kit - Hilux N80, 3M 5952, 2x 25x8mm	
<b>USA Market ONLY</b>			
6	CPHP029	Plastic Hole Insert, 17.4MM, Black, Tigerlink Hardware CPHP029	

**Small Parts – Contained in Small Parts Kit Bag**

Qty	Part Number	Description
4	M3X12 PAN	SCREW, PAN HEAD PHILLIPS, M3X12X0.5 GR4.6 ZP
4	M3 FLAT WASHER	Flat Washer M3, 7mmODx0.5mm T
4	M3 NUT	Hex Nut, M3x0.5 G48.8 ZP
8	M4X20 PAN	SCREW, PAN HEAD PHILLIPS, M4X20X0.7 GR4.6 ZP
8	M4 FLAT WASHER	Flat Washer M4, 8mmODx0.8mm T
8	M4 FLANGE NUT	Flange Nut, M4
2	M5X20 PAN	SCREW, PAN HEAD PHILLIPS, M5X20X0.8 GR4.6 ZP
2	M5 X 20 HEX	M5X20 HEX BOLT, ZP, 8.8
4	M5X15 BHCS BZP	SCREW, BUTTON HEAD CAP, M5X15X0.8 GR12.9 ISO4042 ZnNi BLACK PASSIVATED FINISH
4	M5 Flat washer	M5 FW
4	M5 Flat washer BZP	M5 Flat Washer, 10x5.3x1, ISO4042 ZnNi BLACK PASSIVATED FINISH
8	M5 FLANGE NUT	Flange Nut, M5x0.8 G8.8 ZP
53	M6x16 BHCS BLACK ZINC	SCREW, BUTTON HEAD CAP, M6X16X1 GR12.9, ISO4042 ZnNi BLACK PASSIVATED FINISH
53	M6 FLAT WASHER BLACK ZINC	M6 Flat Washer, 12x6.1x1, ISO4042 ZnNi BLACK PASSIVATED FINISH
35	M6 FLANGE NUT	Flange Nut, M6x1 G8.8 ZP
18	M6CN3MM	CAGE NUT M6x2.6-3.5
4	M8 X 12 HEX	Bolt Hex, M8X12X1.25, GR8.8 ZP
7	M8 X 20 HEX	Bolt Hex, M8X20X1.25, GR8.8 ZP
2	M8 X 40 HEX	Bolt Hex, M8X40X1.25, GR8.8 ZP
2	M8 X 16 BHCS BZP	SCREW, BUTTON HEAD CAP, M8X16X1.25 GR12.9, ISO4042 ZnNi BLACK PASSIVATED FINISH
4	M8 X 20 BHCS BLACK ZINC	SCREW, BUTTON HEAD CAP, M8X20X1.25, ISO4042 ZnNi BLACK PASSIVATED FINISH
9	M8 FLAT WASHER	M8 FW
6	M8 HD FLAT WASHER	M8 FLAT WASHER - High Tensile 19x8x1.9mm
6	M8 FLAT WASHER- BLACK ZINC	M8 FLAT WASHER, 16.5x8.4x1.2, ISO4042 ZnNi BLACK PASSIVATED FINISH
2	M8 NYW	Washer, M8, Nylon
7	M8 FLANGE NUT	Flange Nut, M8x1.25 G8.8 ZP
2	M8 NYLOC	NYLOC SELF LOCKING NUT, ST STL A2 ISO
8	M10 x 25	Bolt Hex, M10X25x[1.5], GR8.8 ZP
8	M10 Flat Washer	M10 FW
8	M10 FLANGE NUT	Flange Nut, M10x1.5 G8.8 ZP
8	M12X30	Bolt Hex, M12X30x1.75, GR8.8 ZP
10	M12 FW LHD	M12 FW Large Heavy Duty
6	M12 FLANGE NUT	Flange Nut, M12x1.75 G8.8 ZP
2	M12 Nyloc nut	M12 NYLOC NUT
2	M14X150 GR10.9	Bolt Hex, M14X150x2.0, GR10.9 ZP
2	M14 FW LHD	WASHER, FLAT M14X30X3.8 ZP
2	M14 FLANGE NUT	Flange Nut, M14x2.0 G8.8 ZP
2	NP-COM-M8-200-ASM0	M8 Nut Plate 200mm
2	P-0282	WL Predator Front Mount Chassis Brace Backing Plate
2	T-0063	WL Predator Crush Tube 122mm

## TOOLS REQUIRED

The following tools will be required to install the product.

<b>Hand Tools</b>	<b>Power Tools</b>	<b>Workshop Equipment</b>
Metric Socket Set 5.5-19mm	Electric/Air Impact Driver (Optional)	Masking Tape
13/32" Imperial Socket (optional)	Power drill	Marker Pen
Socket Extension Bar	Air Hacksaw or	Ruler
Metric Spanner Set 5.5-19mm	Oscillating Multi Tool or	Isopropyl Alcohol
Hex (Allen) Key Set 4-6mm	Angle Grinder or	Rag
Torx Key Set	Jigsaw	Cable Ties
Trim Removal Tool	Soldering iron or	Panel Stand or
Plastic Auto Trim Tool Set	Heat gun (optional)	Soft Blanket
Flat Blade Screwdriver Set		Crimp terminals or
Phillips Head Screwdriver Set		Solder wire or
Utility Knife		Solder splice
Side Cutters		Lifting trolley (optional)
Pliers		
Drill bit set		
Crimping tool (optional)		

# WORKSHOP SAFETY

It is the responsibility of the installer to always complete works in a safe manner. Make sure the following safety equipment is available and precautions are observed whilst fitting this product.

<p>Hearing Protection</p> 	<p>Always wear ear protection when using power tools.</p>
<p>Eye Protection</p> 	<p>Ensure eye protection is always worn when cutting or drilling.</p>
<p>Manual Handling</p> 	<p>Do not attempt to lift bar assemblies or rock sliders on your own.</p> <p>Always use two people to lift or use mechanical Lifting aid such as hydraulic lifting trolley.</p>
<p>Vehicle Support</p> 	<p>Always ensure vehicle is properly supported when working on it. Do not attempt to fit products whilst suspension work is being carried out. Do not work under a vehicle supported only by a jack.</p>

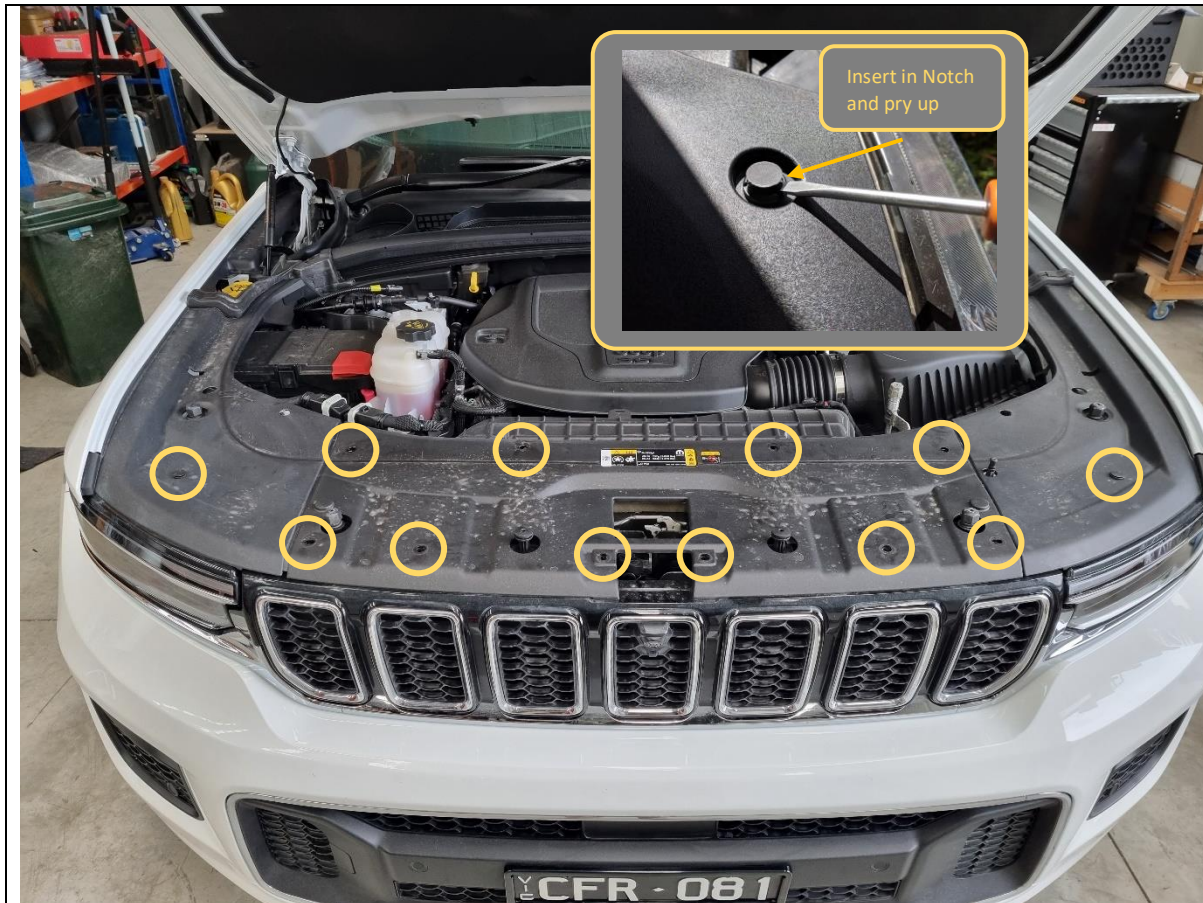

Please note, this bar is not compatible with headlight washers. The washer system can still remain attached to the vehicle, but their operation will be blocked by the bar work. This only affects Australian market Grand Cherokee L 7-seater models.

1. Open the bonnet (hood).
2. Remove 12x plastic push rivets by levering centre section upwards using flat bladed screwdriver or trim tool, as shown.
3. Lift and remove the radiator cover.

**TOOLS REQUIRED**

Flat Blade Screwdriver  
or  
Trim Tool

**FASTENERS**

12x Plastic Push Rivets  
  
Retain for Reassembly



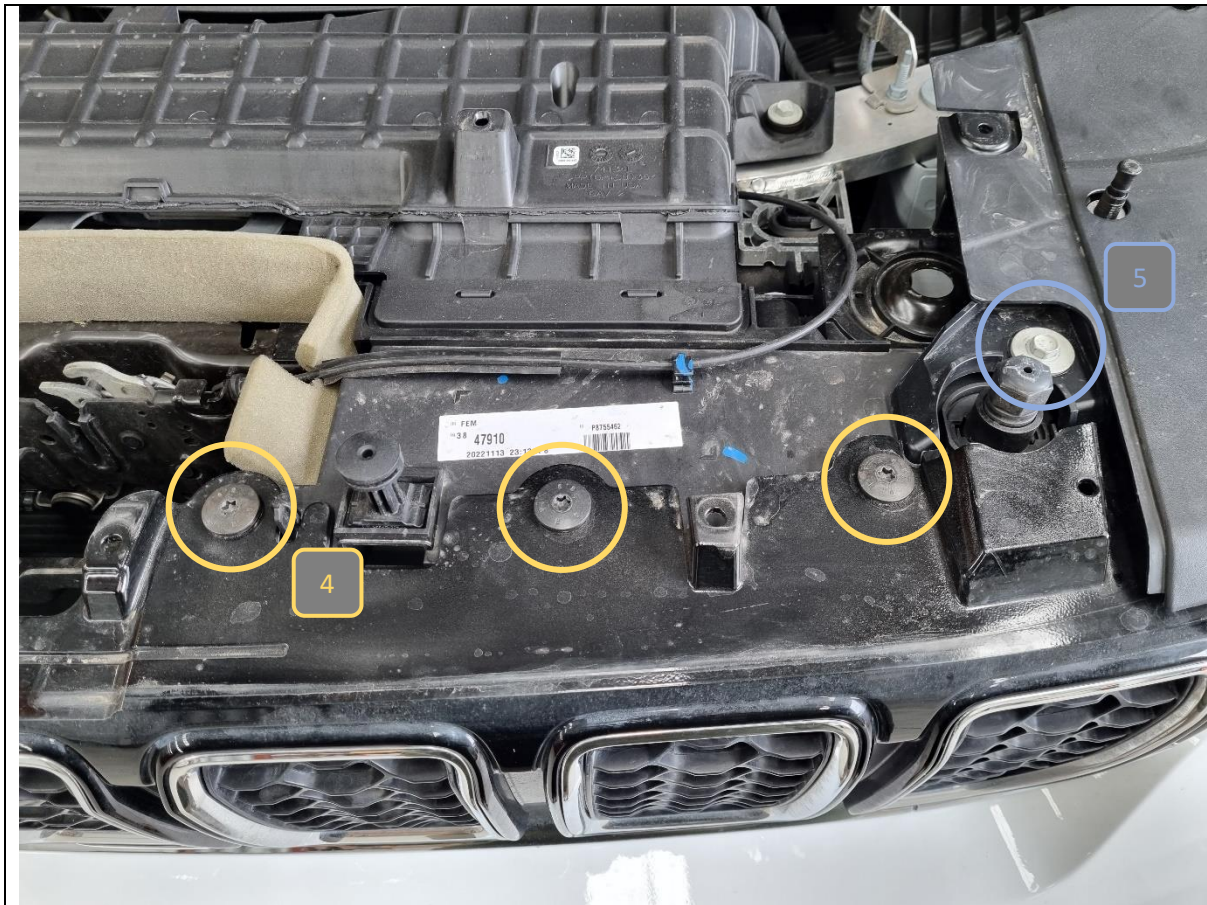

4. Remove 6x T40 Torx screws from the top of the grille.
5. Remove 2x 10mm hex head bolts from the top of the grille.

**TOOLS REQUIRED**

T40 Torx driver  
10mm socket/spanner

**FASTENERS**

6x T40 Torx screws  
2x 10mm hex head bolts  
Retain for Reassembly

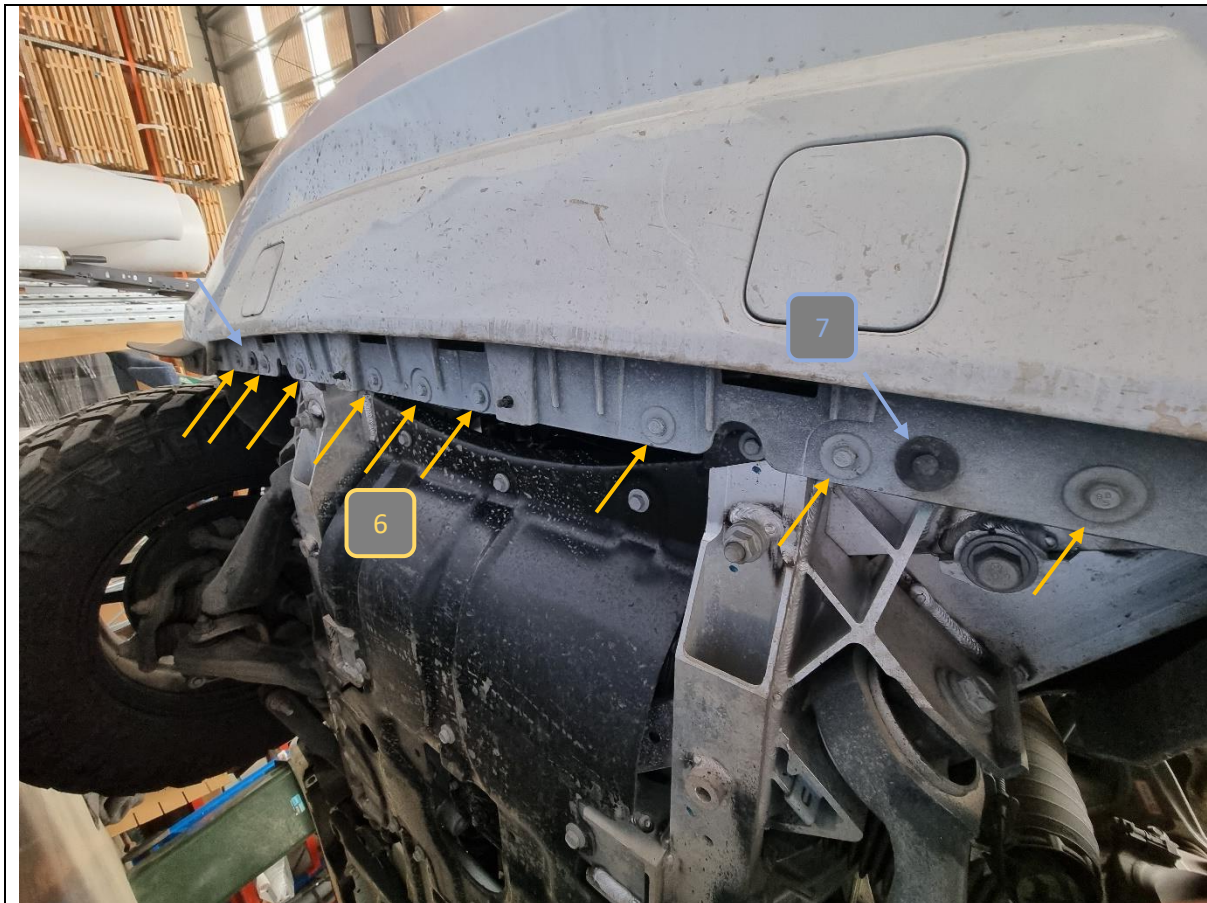

6. Remove 9x 10mm hex head bolts from the bottom of the bumper.

7. Remove 2x plastic push rivets from the bottom of the bumper.

Please note the bolt arrangement on other models may be different to the Overland shown. In any case, remove all fasteners on the bottom of the bumper.

**TOOLS REQUIRED**

10mm socket/spanner

Flat Blade Screwdriver  
or  
Trim Tool

**FASTENERS**

9x 10mm hex head bolts

2x Plastic Push Rivets

Retain for Reassembly



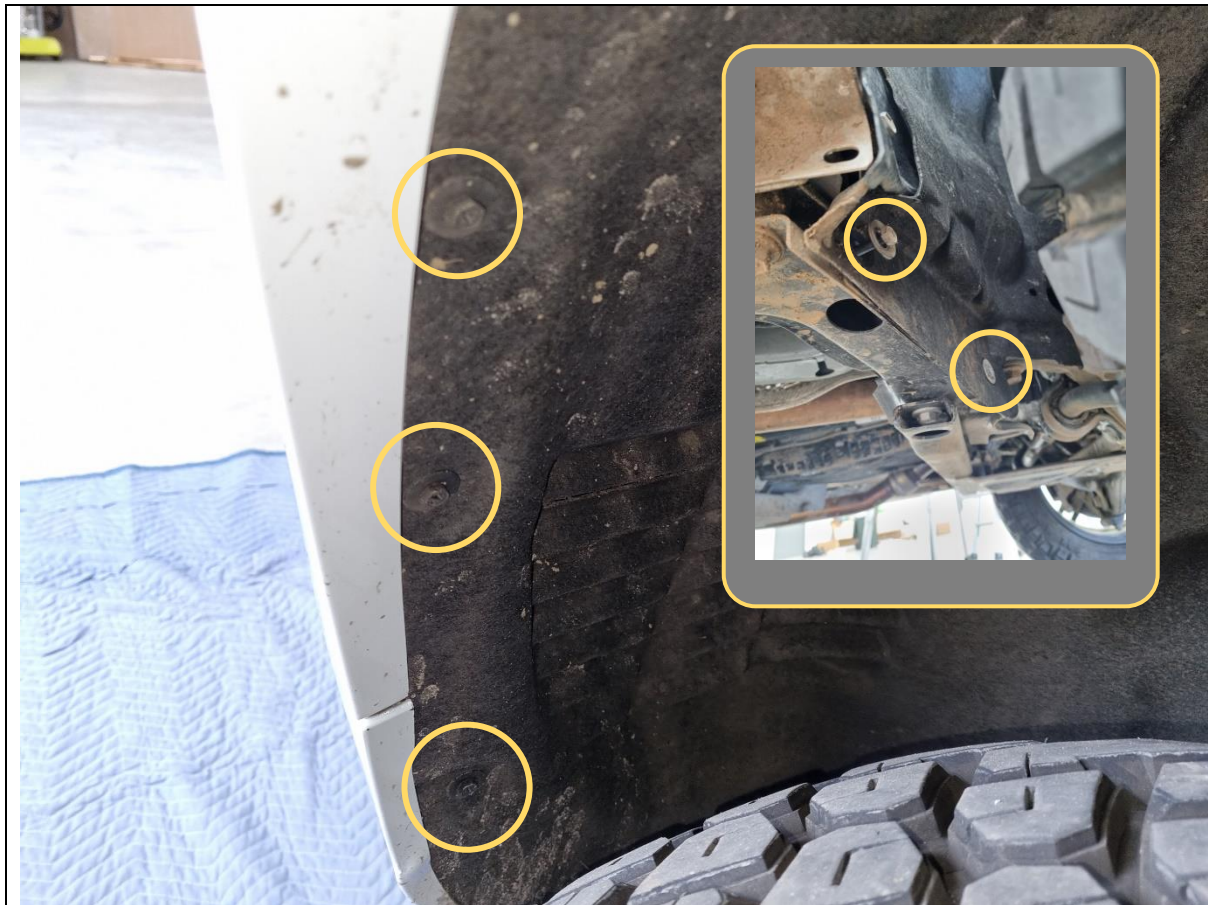

8. On each side, remove 8x 8mm hex head screws securing the wheel arch liner to the bumper/quarter panel.
9. Also remove 2x 10mm hex head bolts securing the back of the wheel arch liner to the body.

**TOOLS REQUIRED**

8mm socket/spanner  
or  
Phillips Head screwdriver  
  
10mm socket/spanner

**FASTENERS**

8x 8mm hex head bolts  
(per side)  
  
2x 10mm hex head bolts  
(per side)  
  
Retain for Reassembly

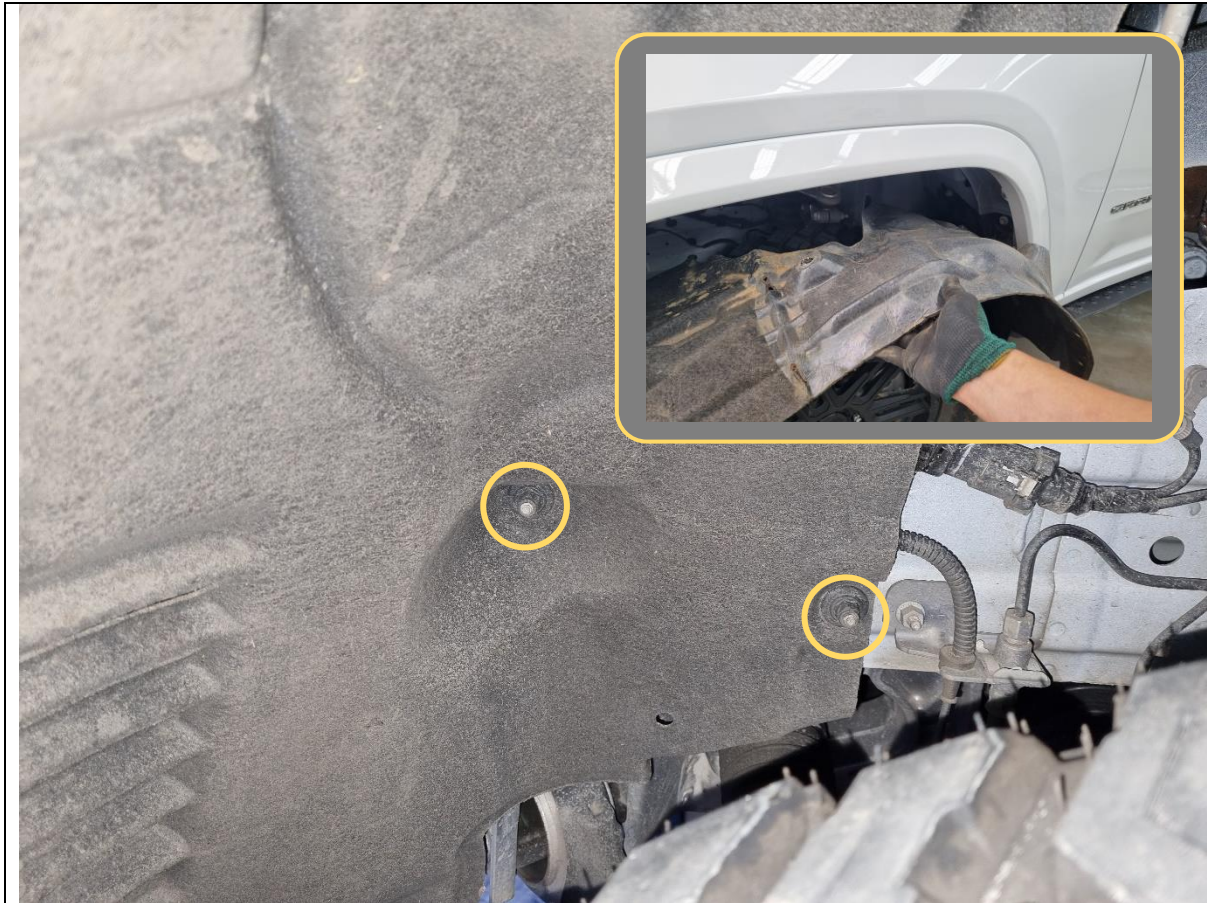

10. Remove 7x black plastic nuts securing the wheel arch liner to the body using a 10/11mm metric or 13/32" imperial socket.

11. Fully remove the wheel arch liner.

**TOOLS REQUIRED**

10/11mm metric socket  
or  
13/32" imperial socket

**FASTENERS**

Plastic nuts  
  
Retain for Reassembly



12. Mark the wheel arch flare where it will need to be cut.

13. Use masking tape to protect the flare, then use a ruler or similar to mark out a straight line on the flare that runs parallel with the edge of the quarter panel/bumper, as shown.

**TOOLS REQUIRED**

Masking Tape

Marker Pen

Ruler

**FASTENERS**





14. Pull and release the clips retaining the flare to the bumper + quarter panel.

It is easiest to insert an 8mm socket on the inside and push the trim clips outwards (see inset photos).

15. Set aside the flare for trimming later.

**TOOLS REQUIRED**

8mm socket (optional)

Rag

**FASTENERS**



16. On both sides, remove the 10mm hex head bolt securing the bumper to the quarter panel (fender).
17. Disconnect sensor looms, camera loom and washer hoses on both sides of the bumper (see inset photos).

There should be 1x sensor loom plug each side, a camera loom plug on the LH, and washer hose on the RH.

It is advised to clamp the camera washer hose before detaching, to prevent fluid leakage.

**TOOLS REQUIRED**

10mm socket

**FASTENERS**

2x 10mm hex head bolts

Retain for Reassembly



18. If headlight washers are equipped, pull out the plastic cover cap and unclip it from the plastic washer stem.

**TOOLS REQUIRED**

**FASTENERS**





19. Remove the bumper by releasing the clips on either side and lifting the top flap of the grille over the bonnet rubber stops.

20. Set the bumper aside in a safe place for later.

**TOOLS REQUIRED**

**FASTENERS**

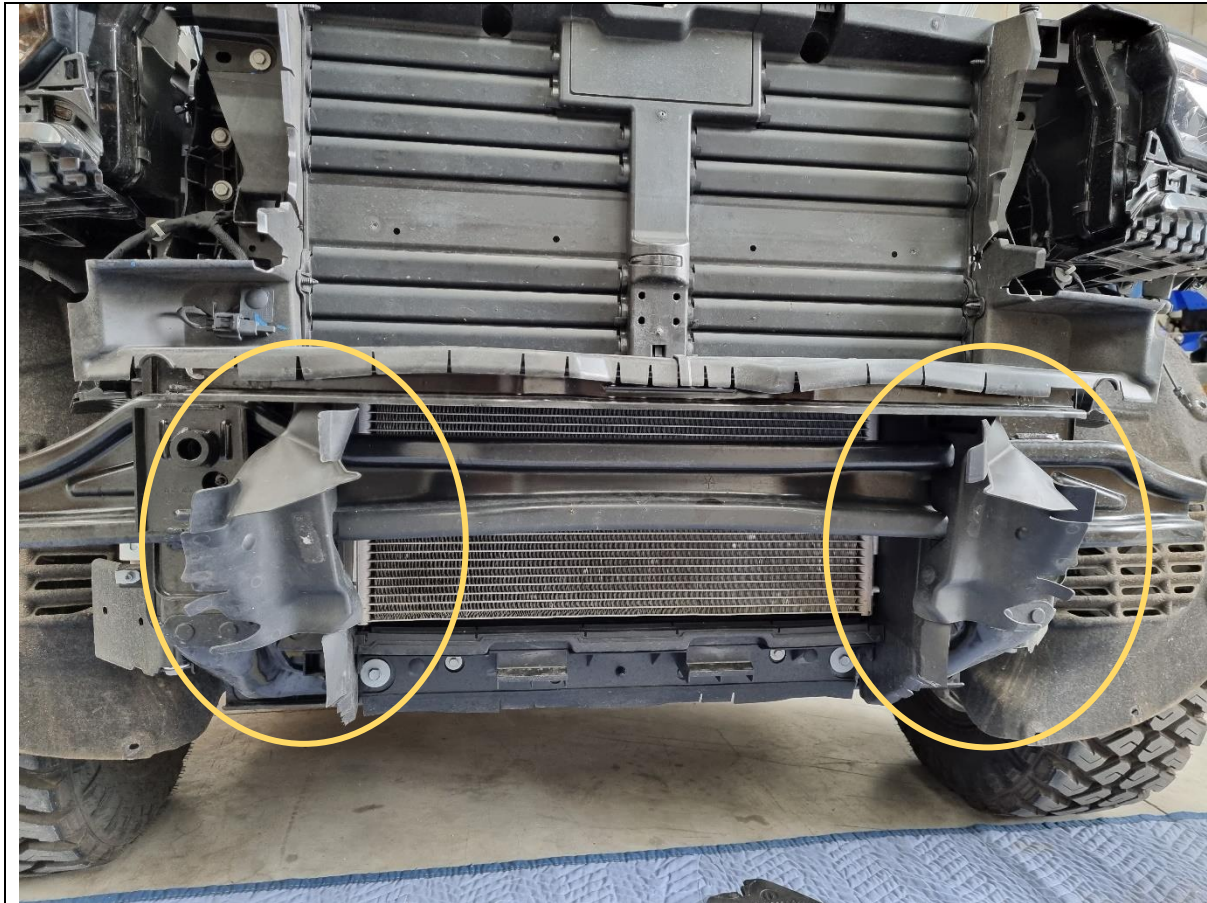

21. Unclip and remove the air dams with a flat head screwdriver or trim tool.

**TOOLS REQUIRED**

Flat Blade Screwdriver  
or  
Trim Tool

**FASTENERS**



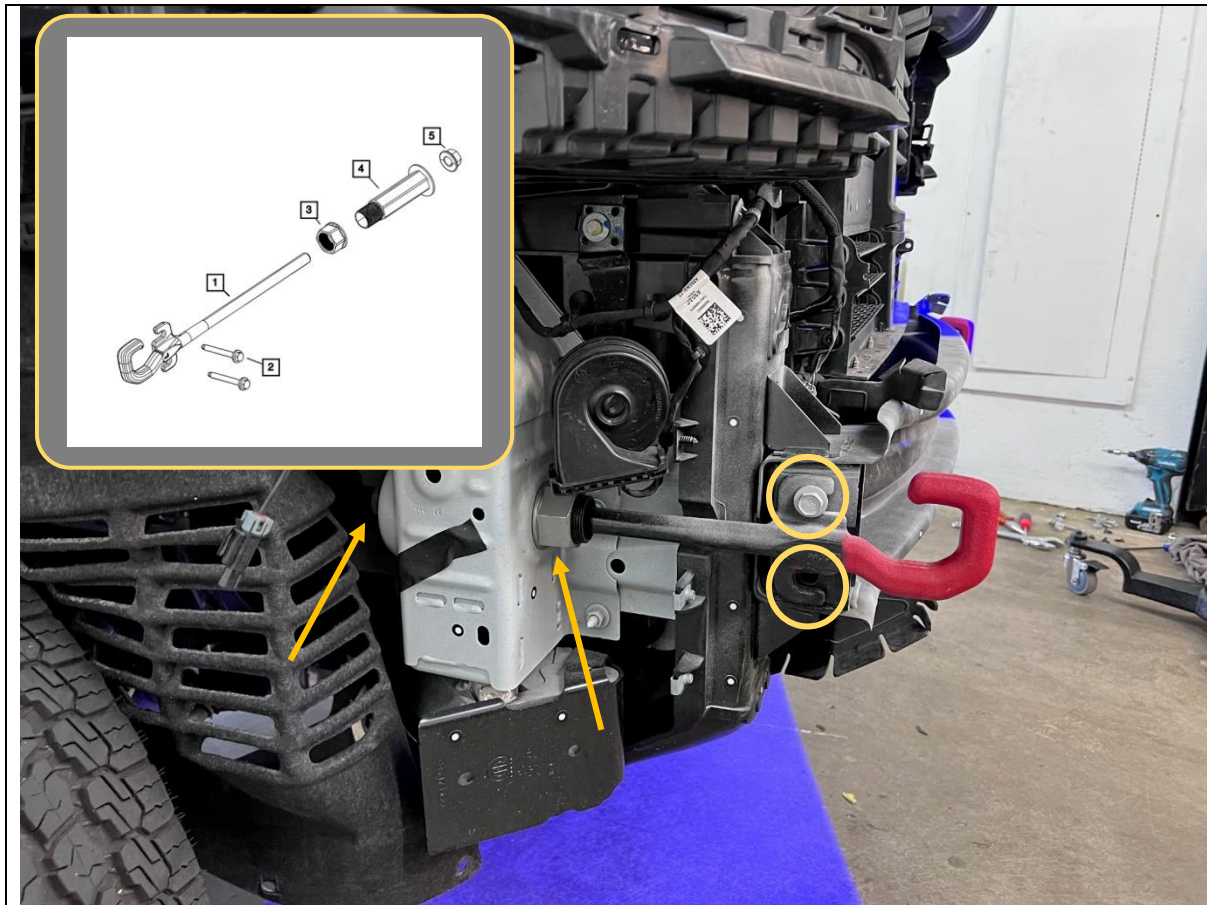

22. If factory tow hooks are equipped, remove them by undoing the 2x 16mm hex head bolts on each side, then remove the large nuts with a large adjustable wrench (see inset for Jeep parts breakdown).

**TOOLS REQUIRED**

16mm socket/spanner

Adjustable wrench

**FASTENERS**

4x 16mm hex head bolts



- 23. Using a 16mm socket or spanner, remove the 4x hex head bolts securing the impact beam to the body.
- 24. Retain fasteners for bar assembly.

**TOOLS REQUIRED**

16mm socket/spanner

**FASTENERS**

4x 16mm hex head bolts

Retain for reassembly



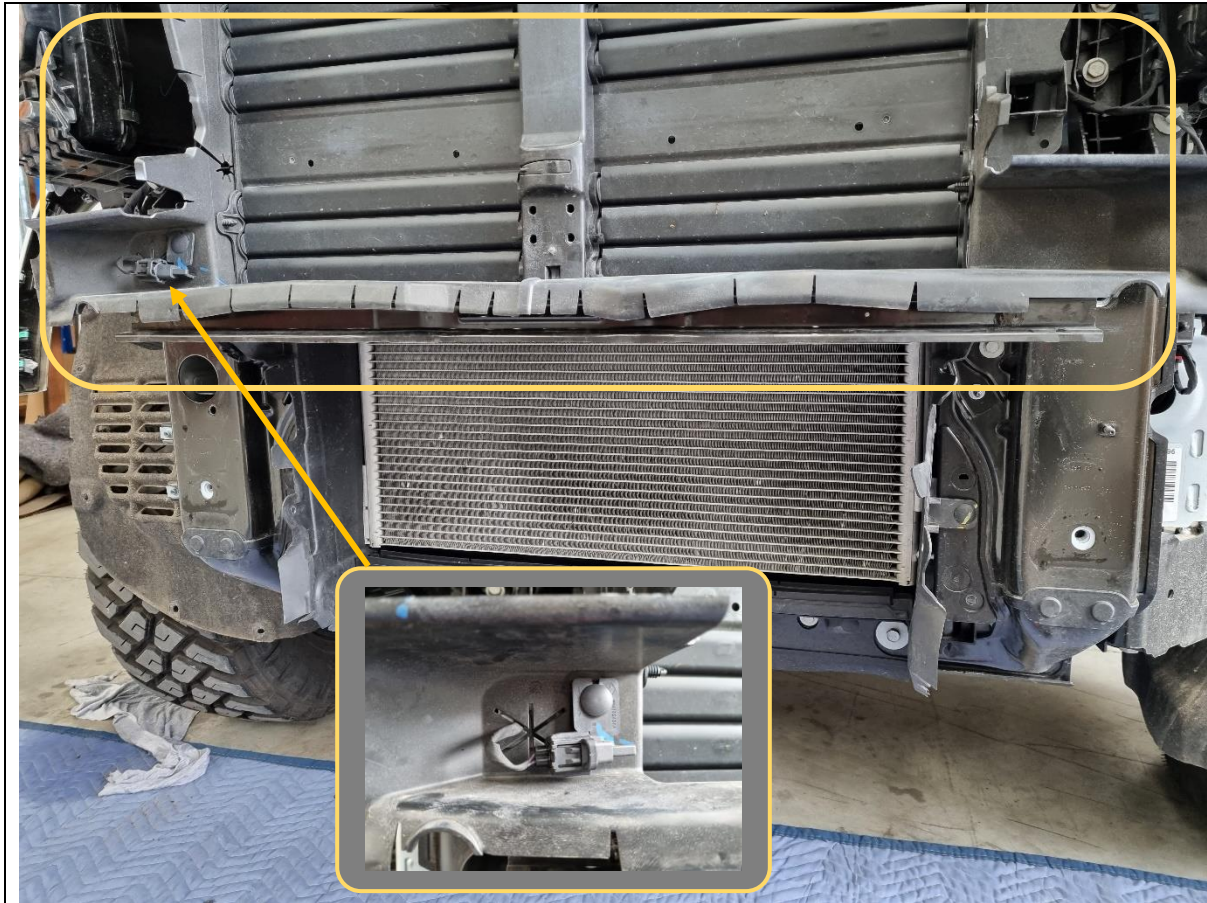

25. Unclip the air temperature sensor from the upper air dam using a flat head screwdriver or trim tool.
26. Unclip and remove the upper air dam.
27. The air temperature sensor can be reclipped into one of the holes left over from the air dam.

**TOOLS REQUIRED**

Flat Blade Screwdriver  
or  
Trim Tool

**FASTENERS**

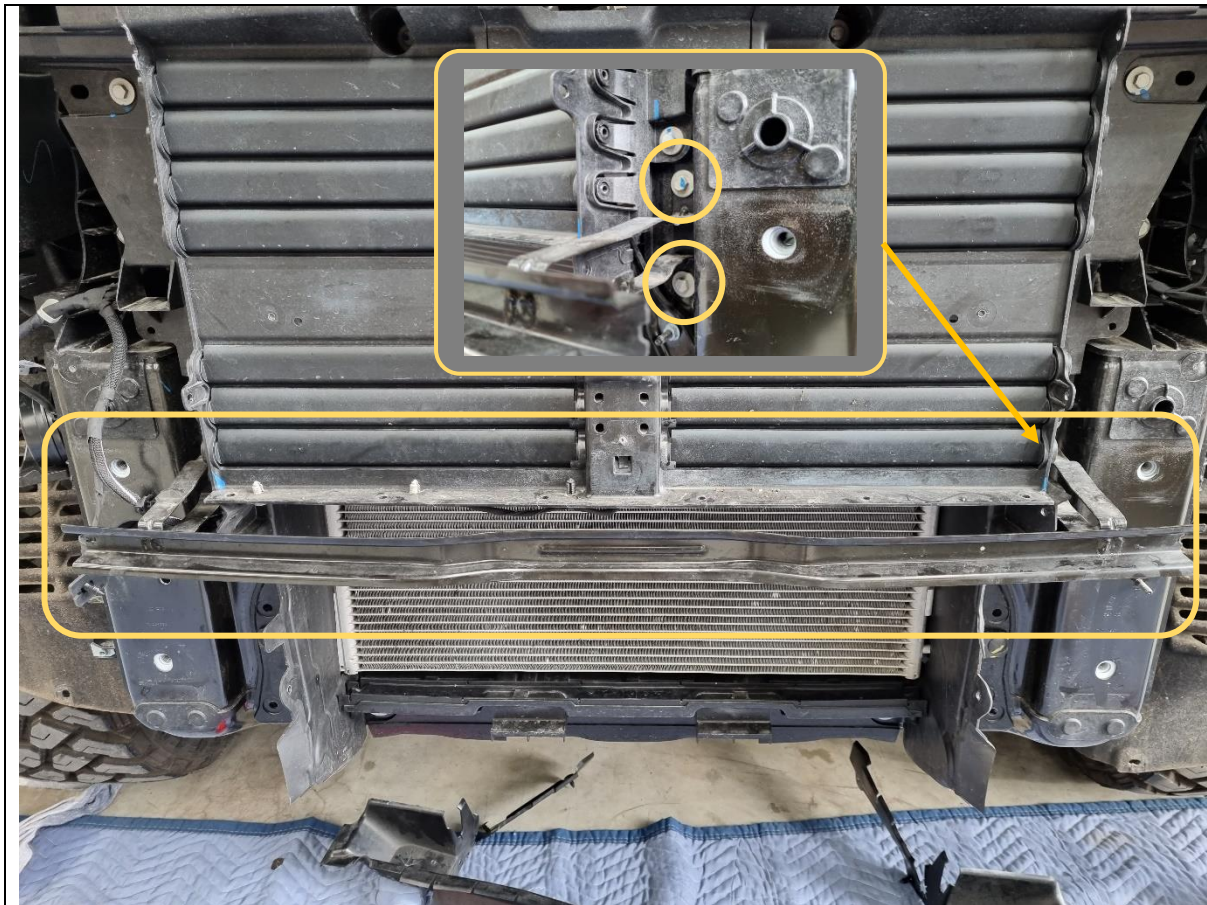

28. Remove the steel cross beam by removing the 4x 10mm hex head bolts securing it to the body (see inset).

**TOOLS REQUIRED**

10mm socket

**FASTENERS**





29. Unclip and remove the lower air dams with a flat head screwdriver or trim tool.

**TOOLS REQUIRED**

Flat Blade Screwdriver  
or  
Trim Tool

**FASTENERS**



- 30. For 4xe vehicles, unplug and remove the pedestrian alert speaker on the RHS behind where the impact beam was, using a T35 Torx bit. Set aside for later.
- 31. Unclip any looms attached to the sides of the chassis front end.
- 32. Bend the horn bracket upwards and out of the way by hand (see result on page 28).
- 33. On all vehicles, cut off all the plastic mounting tabs on the sides of the chassis front end using a utility knife.

**TOOLS REQUIRED**

- T35 Torx driver
- Utility knife

**FASTENERS**

- 2x T35 Torx screws



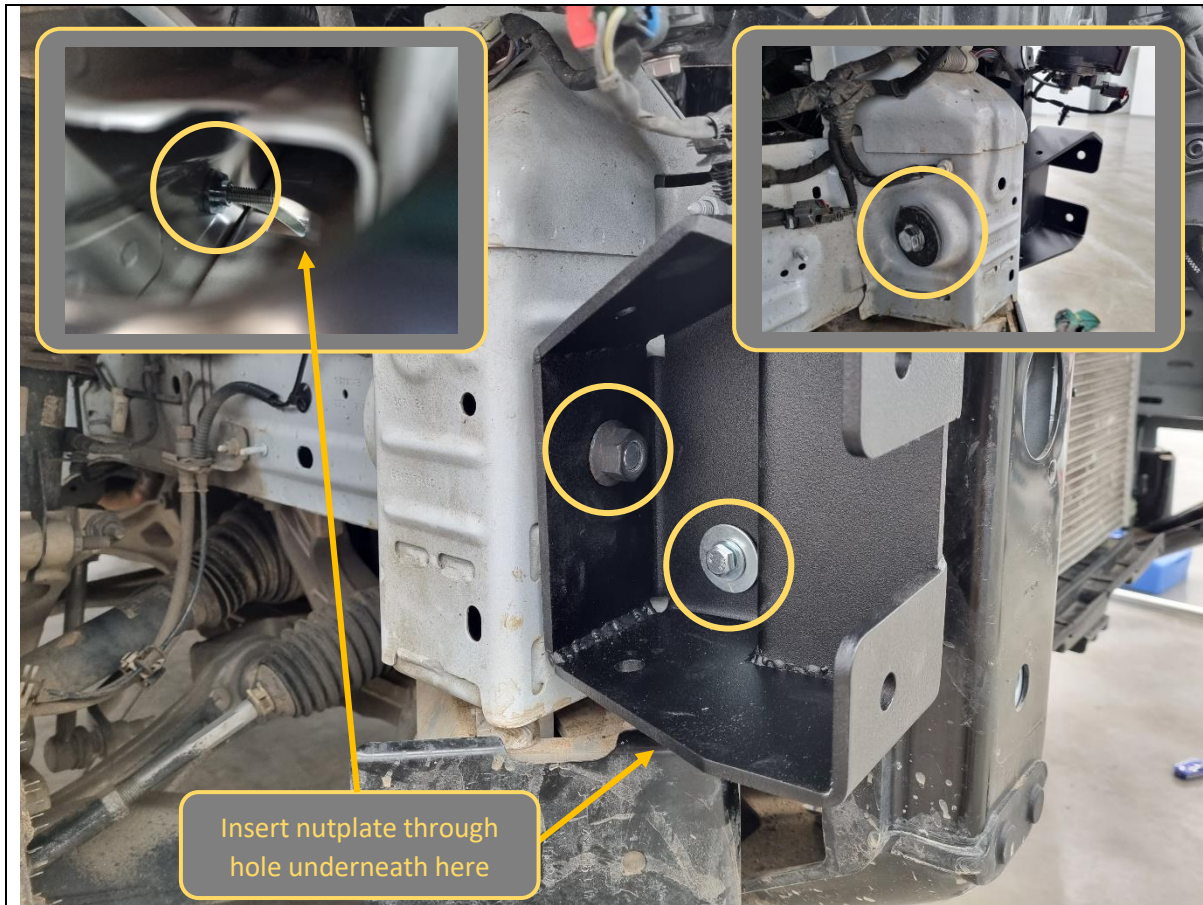

34. Loosely fit the front mount chassis brace bracket to the body with 1x M8 lollipop nutplate through the rectangular hole (see left inset) and 1x M8x40 hex head bolt + heavy duty flat washer.
35. Also loosely secure the bracket at the rear with 1x M14x150 hex head bolt, flat washer, large black backing plate, 122mm crush tube and flange nut. Feed the bolt with crush tube through the large hole at the rear (see right inset).
36. Repeat for other side.

**TOOLS REQUIRED**

- 13mm socket/spanner
- 21mm socket/spanner

**FASTENERS**

- 1x M8x40 hex head bolt
- 1x M8 heavy duty washer
- 1x M8 lollipop nutplate
- 1x M14x150 hex head bolt
- 1x M14 flat washer
- 1x P-0282 backing plate
- 1x T-0063 122mm crush tube
- 1x M14 flange nut

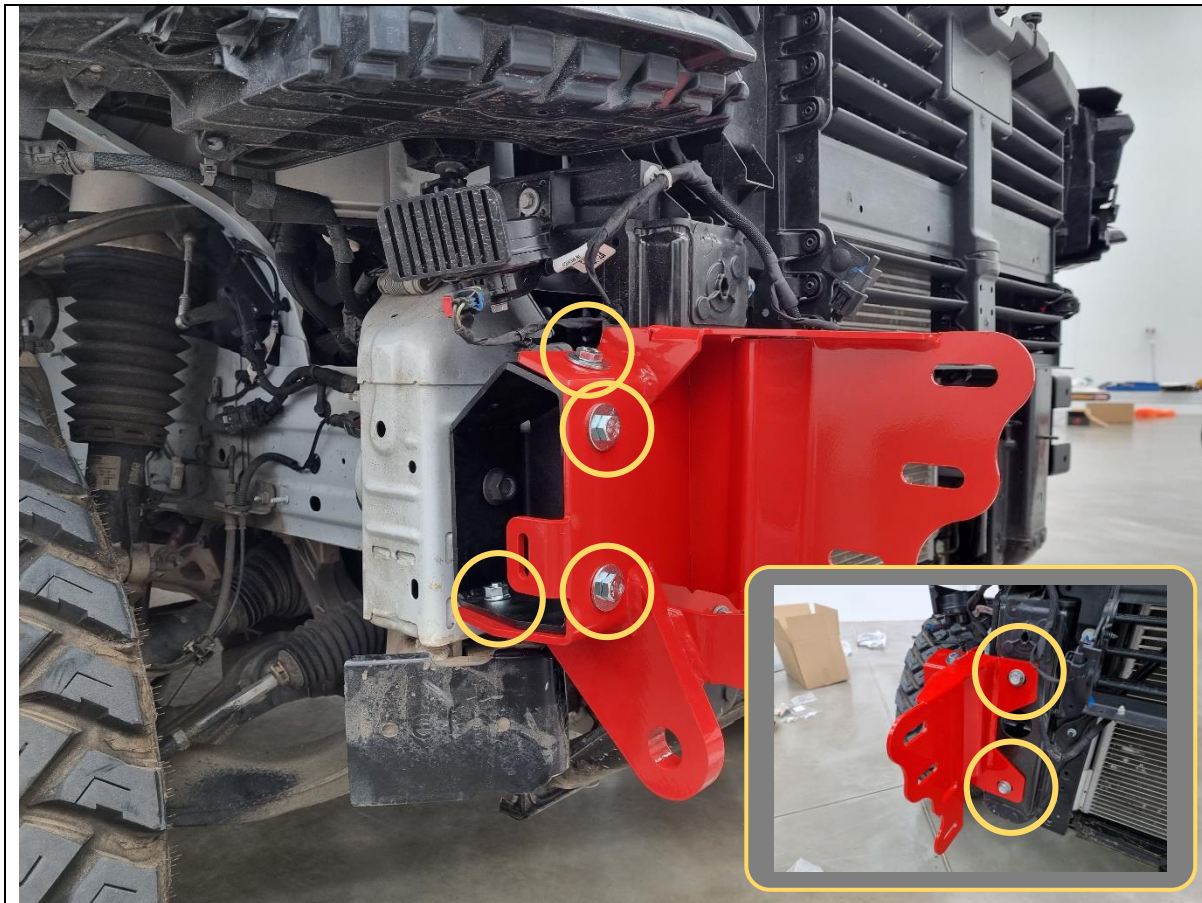

- 37. Loosely fit the impact assembly onto the chassis.
- 38. Loosely secure the outside of the impact assembly to the chassis brace bracket with 4x M10x25 hex head bolts, heavy duty washers and flange nuts.
- 39. Loosely secure the inside of the impact assembly to the chassis with 2x factory 16mm hex head bolts retained from Step 23.
- 40. Repeat for other side.

**TOOLS REQUIRED**

16mm socket/spanner

**FASTENERS**

8x M10x25 hex head bolt  
8x M10 heavy duty washer  
8x M10 flange nut  
  
4x 16mm hex head bolts



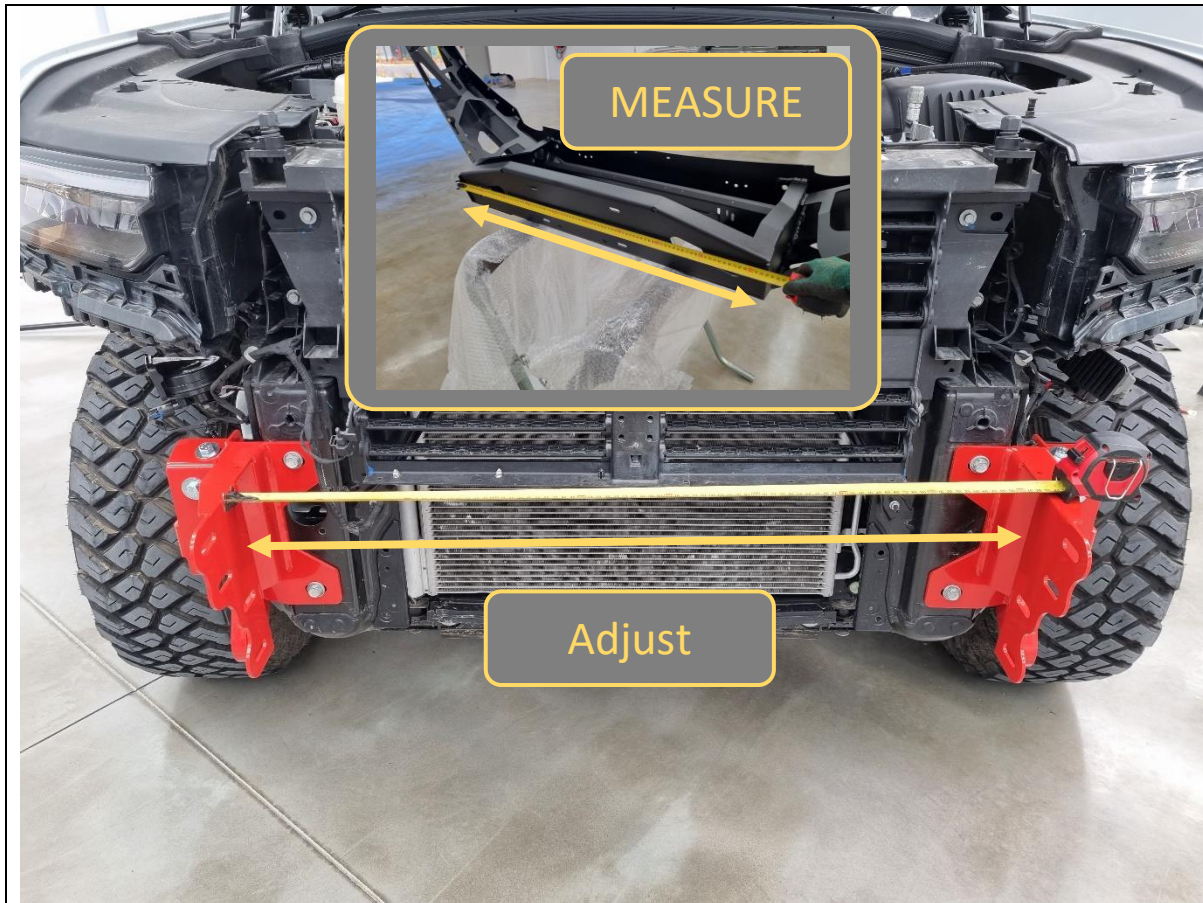

<p>41. Measure the distance between the outside faces of the uprights inside the Predator bar using a tape measure. Write distance below for reference if required.</p> <p>Bar upright width = _____ mm (nominal width is 930mm)</p>	<p><b>TOOLS REQUIRED</b></p> <p>Tape Measure</p> <p>13/16/21mm socket/spanner</p>
<p>42. Adjust the impact assemblies by sliding them left/right on slots, such that distance between the inner faces is approximately 2mm more than bar. Also ensure they are centered on the vehicle.</p> <p>43. Secure and tighten all chassis brace brackets and impact assemblies. Recheck spacing to confirm it is correct.</p>	<p><b>FASTENERS</b></p>

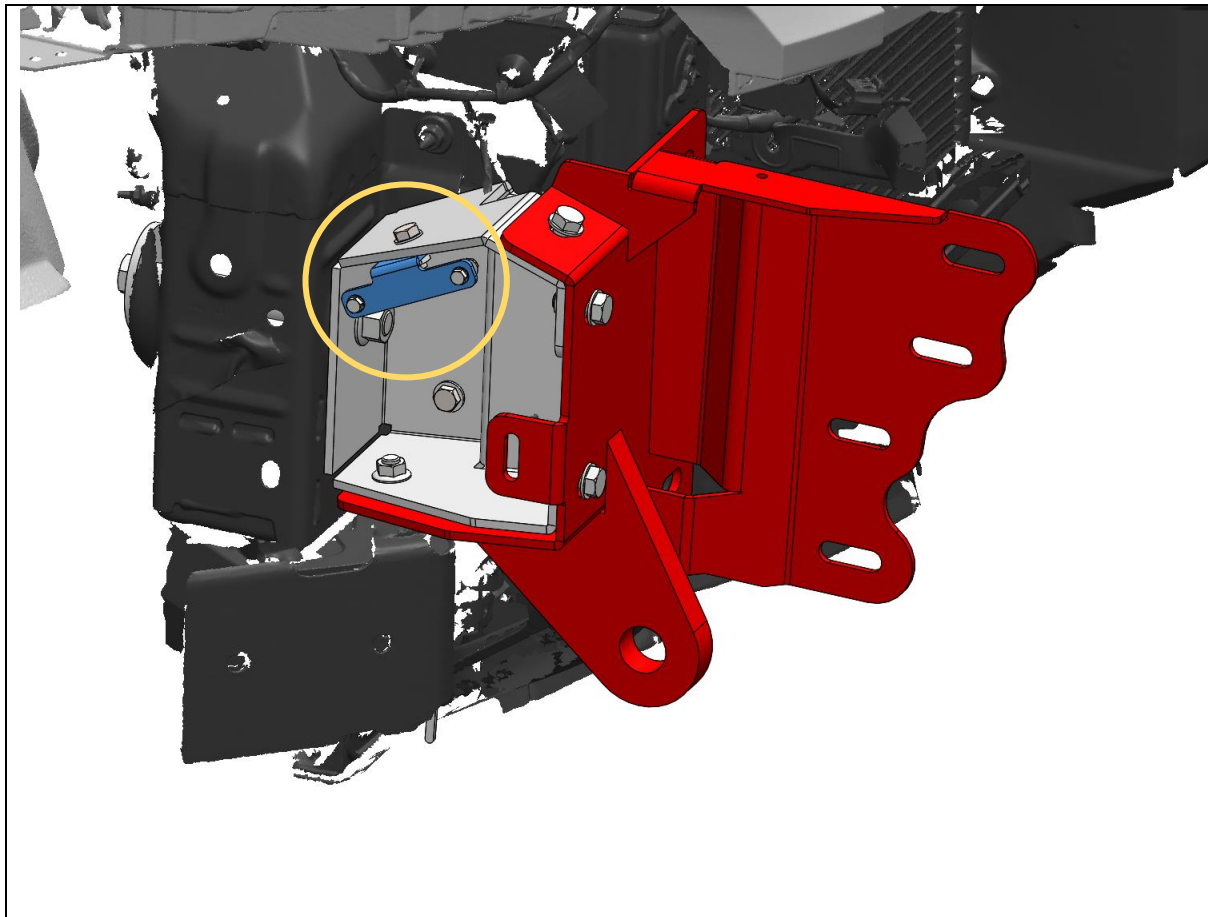

- 44. For 4xe vehicles, bolt the pedestrian alert speaker to the supplied relocation bracket using 2x M5x20 hex bolts, flat washers, and flange nuts.
- 45. Bolt the speaker and bracket to the chassis brace in the location shown using 1x M8x20 hex bolt, flat washer and flange nut.

**TOOLS REQUIRED**

- 8mm socket/spanner
- 13mm socket/spanner

**FASTENERS**

- 2x M5x20 hex bolt
- 2x M5 flat washer
- 2x M5 flange nut
  
- 1x M8x20 hex bolt
- 1x M8 flat washer
- 1x M8 flange nut



- 46. The plastic bumper clips on the ends of the quarter panel (fender) need to be removed. They are held in place with 2x rivets each.
- 47. Drill out the rivets to remove the plastic bumper clip.
- 48. If the rivets become loose and start spinning with the drill bit before the clip comes off, you may need to rely on friction heat to 'melt' the plastic clip off.

**TOOLS REQUIRED**

Electric power drill

Drill bits

**FASTENERS**





- 49. Replace the rivets with supplied M5x15 black button head bolts, washers, and flange nuts. This is used to secure the quarter panel (fender).
- 50. If the rivets are still intact from removing the bumper clip, you may retain them as is.

**TOOLS REQUIRED**

3mm hex/Allen key

**FASTENERS**

4x M5x15 black button head  
4x M5 black flat washer  
4x M5 flange nut

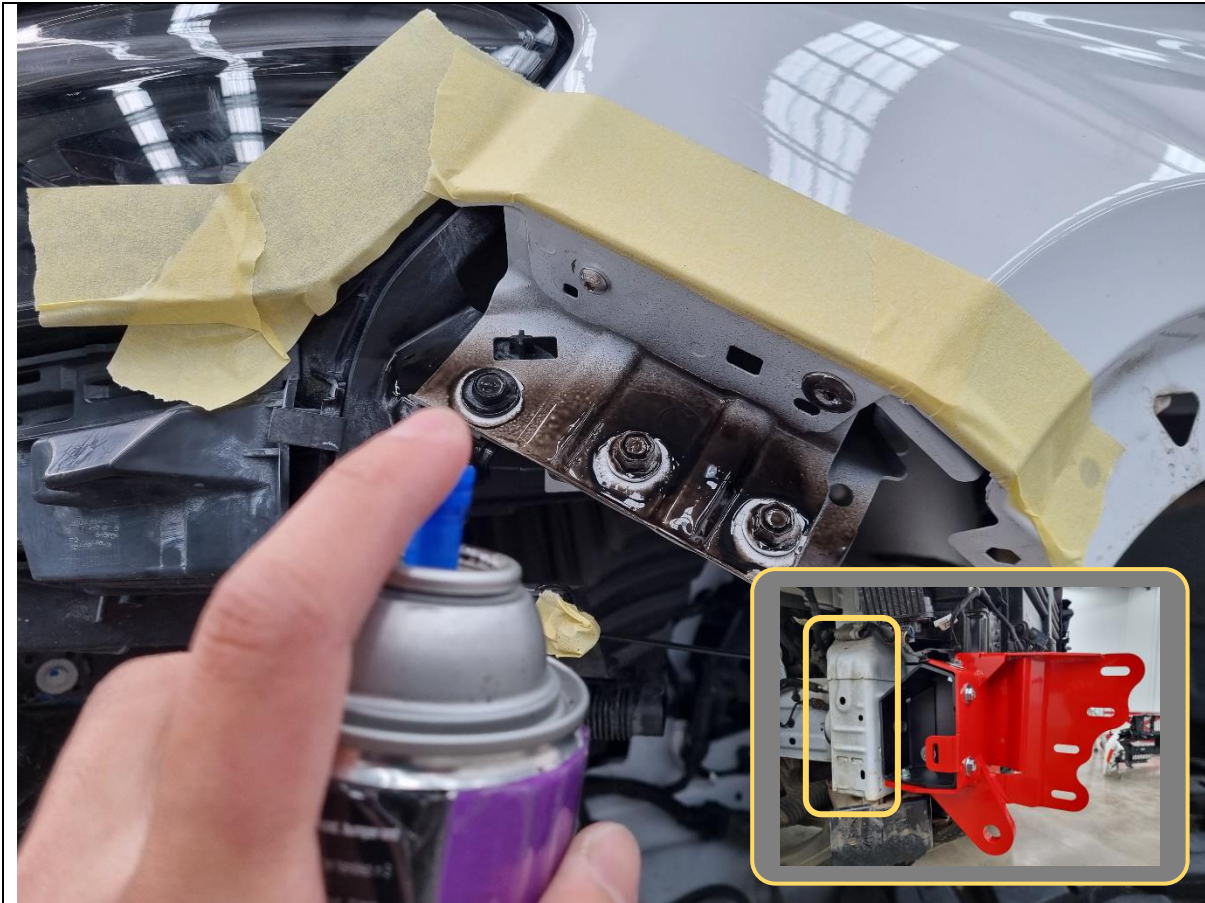

- 51. It is recommended that for light coloured vehicles, you mask off the fender corner and paint the exposed bodywork with black spray paint for a better overall look.
- 52. It is also recommended to paint the frame box section behind the chassis brace (see inset).

**TOOLS REQUIRED**

- Masking tape
- Black spray paint

**FASTENERS**



53. Fit 5x M6 cage nuts each side into the rectangular slots on the bottom of the bar wing.

To aid fitting, use a small flat blade screwdriver to push the edge of the cage nut to engage with the slot.

**TOOLS REQUIRED**

Flat head screwdriver

**FASTENERS**

10x M6 cage nut





54. Bolt the supplied LED AutoLamps 7922 side marker light to the outer end of the bar using 2x M3x12 pan head screws, flat washers and hex nuts.

There is no specific up/down orientation for mounting.

55. Repeat for other side.

**TOOLS REQUIRED**

Phillips head screwdriver

5.5mm socket/spanner

**FASTENERS**

4x M3x12 pan head screw

4x M3 flat washer

4x M3 hex nut

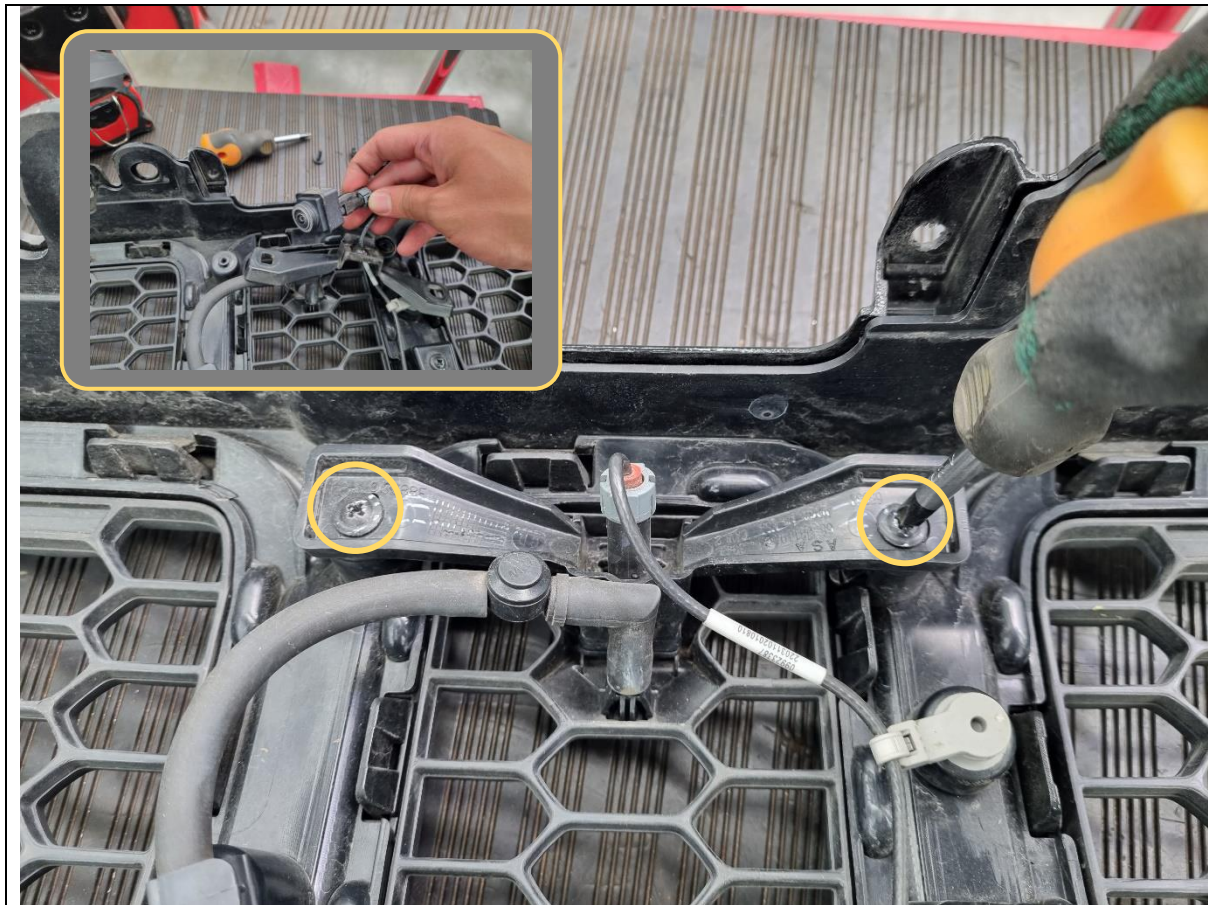

56. It is now time to strip the bumper and transfer all tech over to the bar.

57. The front view surround camera may be optionally relocated onto the bar. This is recommended if fitting the bar with optional driving lights or top tubes that may obstruct the view of the camera.

If not relocating the camera, the view will still be partially obstructed at the bottom by the bar.

58. If relocating, unscrew the 2x screws holding the camera to the grille, using a Phillips head screwdriver.

59. Separate the camera body from the plastic mount, then disconnect and unplug the camera.

**TOOLS REQUIRED**

Phillips head screwdriver

**FASTENERS**





- 60. Disconnect the camera washer hose from the nozzle by pulling and twisting.
- 61. Gently unclip the camera washer nozzle from the grille by pushing in the plastic tabs with a flat blade screwdriver.

**TOOLS REQUIRED**

Flat blade screwdriver

**FASTENERS**



- 62. Clip the washer nozzle into the supplied camera relocation bracket, with the nozzle opening pointing up towards the camera hole.
- 63. Place the camera body in position with the lens poking through the hole in the bracket.
- 64. Ensure the camera orientation matches the image shown with the plug in the bottom.

**TOOLS REQUIRED**

**FASTENERS**





65. Bolt the relocation bracket (with camera clamped in between) to the mesh fairlead panel using 2x M6x16 black button head bolts, black washers and flange nuts.

**TOOLS REQUIRED**

4mm hex/Allen key

**FASTENERS**

2x M6x16 black button head  
2x M6 black flat washer  
2x M6 flange nut



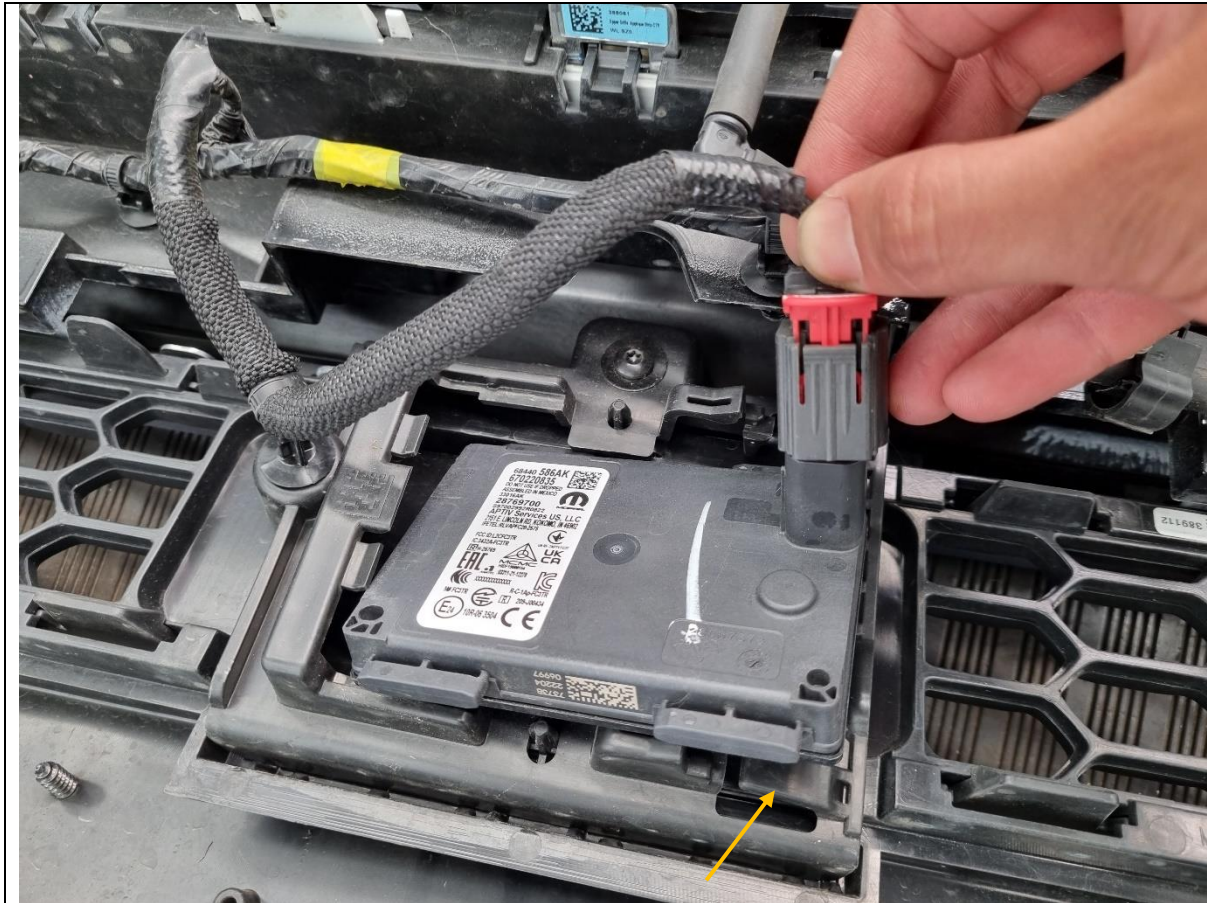

66. Next, note down the orientation of the adaptive cruise control (ACC) radar.

67. Unplug and unclip the radar from the bumper.

To unclip, press down on the plastic tabs and slide the radar out.

**TOOLS REQUIRED**

**FASTENERS**



68. Clip the centre radar into the radar bracket with the plug pointing out the back, away from the folded flange on the bracket.

The bracket sits on top of the radar as shown.

The plastic blocks protruding from the radar will slot into the rectangular slots in the bracket.

**TOOLS REQUIRED**

**FASTENERS**

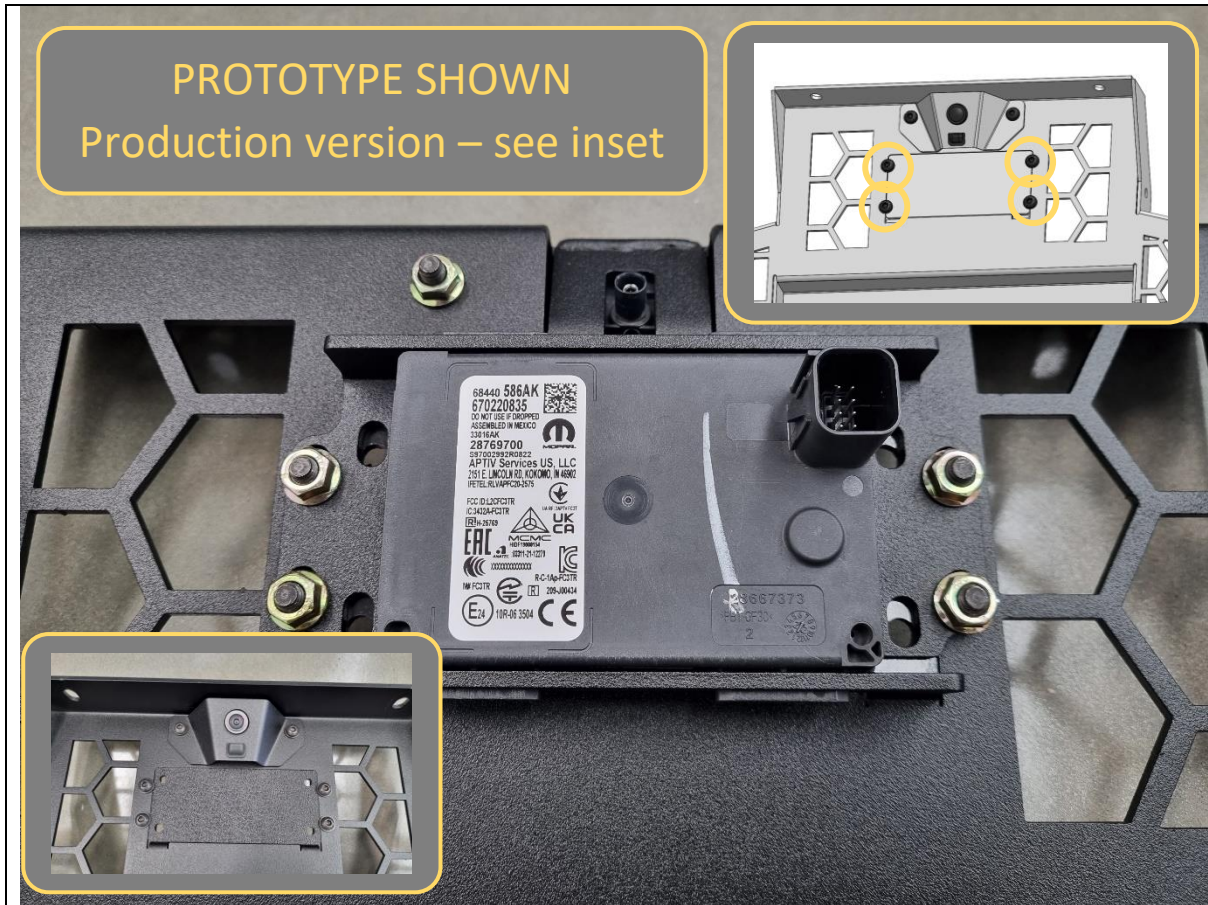

69. Fit the centre radar and bracket to the inside of the mesh fairlead.

The bottom of the radar clips into rectangular slots in the mesh fairlead in the same way as previous.

70. Fit the plastic ACC radar cover (rough texture on exterior) on the outside, then secure it and the radar bracket to the mesh fairlead with 4x M6x16 black button head bolts, washers and flange nuts.

71. Set aside the mesh fairlead for later.

**TOOLS REQUIRED**

4mm hex/Allen key

**FASTENERS**

4x M6x16 black button head  
4x M6 black flat washer  
4x M6 flange nut



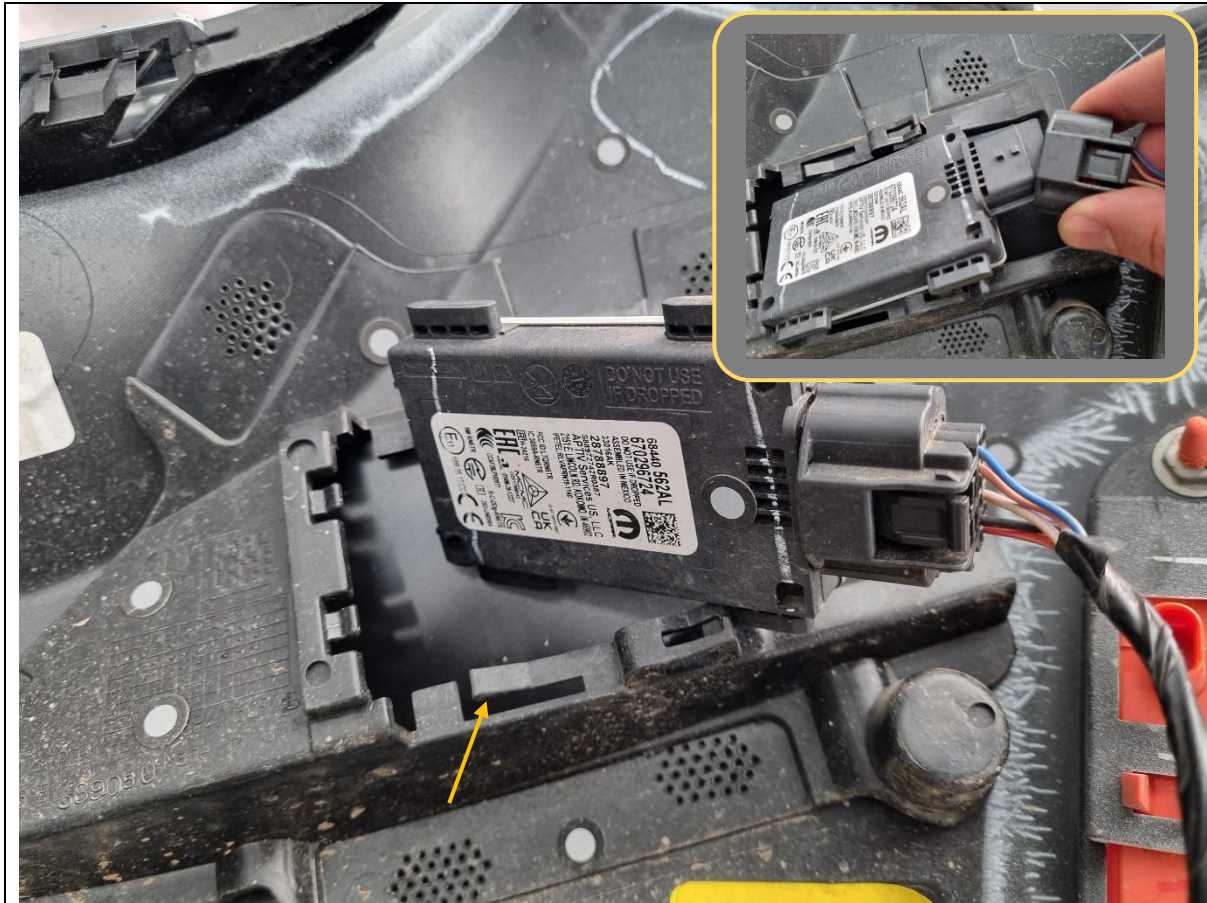

72. Note the orientation, then unclip the side intersection collision assist radars from the bumper by pushing on the plastic tabs highlighted and sliding it out.

73. Unplug the radar from the bumper harness.

**TOOLS REQUIRED**

**FASTENERS**



74. Clip the intersection collision assist radar into the side radar bracket with the plug pointing in the same direction as the arrow cutout in the bracket.

The bracket sits on top of the radar as shown. The white face of the radar is away from the bent flange.

The plastic blocks protruding from the radar will slot into the rectangular slots in the bracket.

**TOOLS REQUIRED**

**FASTENERS**



- 75. Secure the side radar and bracket to the inside of the bar wing using 2x M6x16 black button head bolts, washers, and flange nuts.
- 76. The bottom of the radar clips into rectangular slots in the bar in the same way as previous.
- 77. Repeat for both side radars.

**TOOLS REQUIRED**

4mm hex/Allen key

**FASTENERS**

4x M6x16 black button head  
4x M6 black flat washer  
4x M6 flange nut



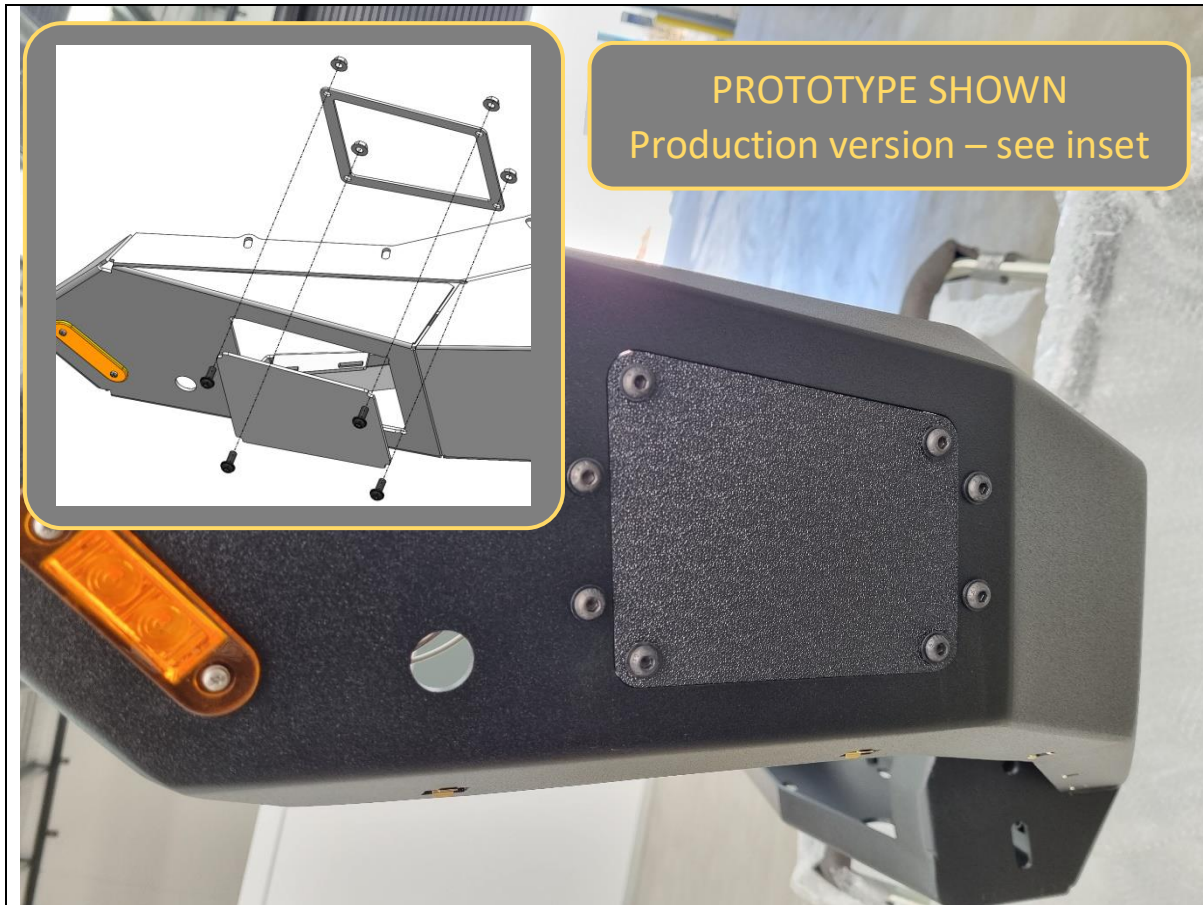

78. Fit the plastic side radar cover (rough texture on exterior) on the outside, then secure it to the bar with steel mount plate on the inside with 4x M6x16 black button head bolts, washers and flange nuts.

79. Repeat on other side.

**TOOLS REQUIRED**

4mm hex/Allen key

**FASTENERS**

8x M6x16 black button head  
8x M6 black flat washer  
8x M6 flange nut

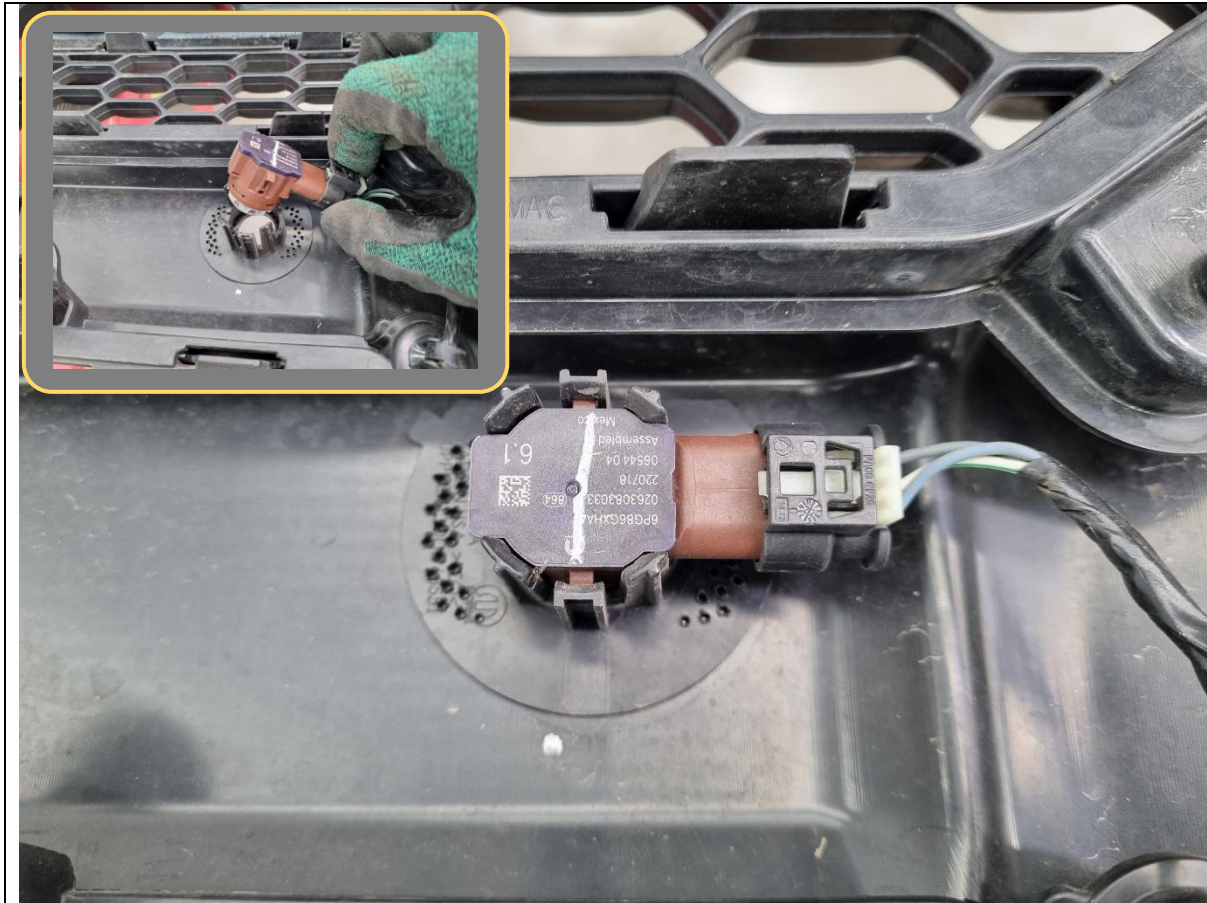

80. If equipped, take note of the location and orientation of all 6x parking sensors.

81. Unclip each sensor from the bumper by spreading open the tabs on the plastic sensor holder.

**TOOLS REQUIRED**

**FASTENERS**



- 82. If fog lights are equipped, unplug and disconnect the wiring harness behind them.
- 83. Unplug and disconnect the wiring harness for the factory side marker lamps.

**TOOLS REQUIRED**

**FASTENERS**





- 84. Use a trim removal tool or flat blade screwdriver and unclip the loom entire wiring harness and camera washer hose from the bumper.
- 85. Separate the entire wiring harness from the bumper with parking sensors still attached.

**TOOLS REQUIRED**

Trim removal tool  
or  
Flat blade screwdriver

**FASTENERS**



86. Transfer the entire harness and parking sensors across to the bar, in the same orientation as the original bumper.

87. Route the harness through holes provided in the bar uprights (see inset).

**TOOLS REQUIRED**

**FASTENERS**

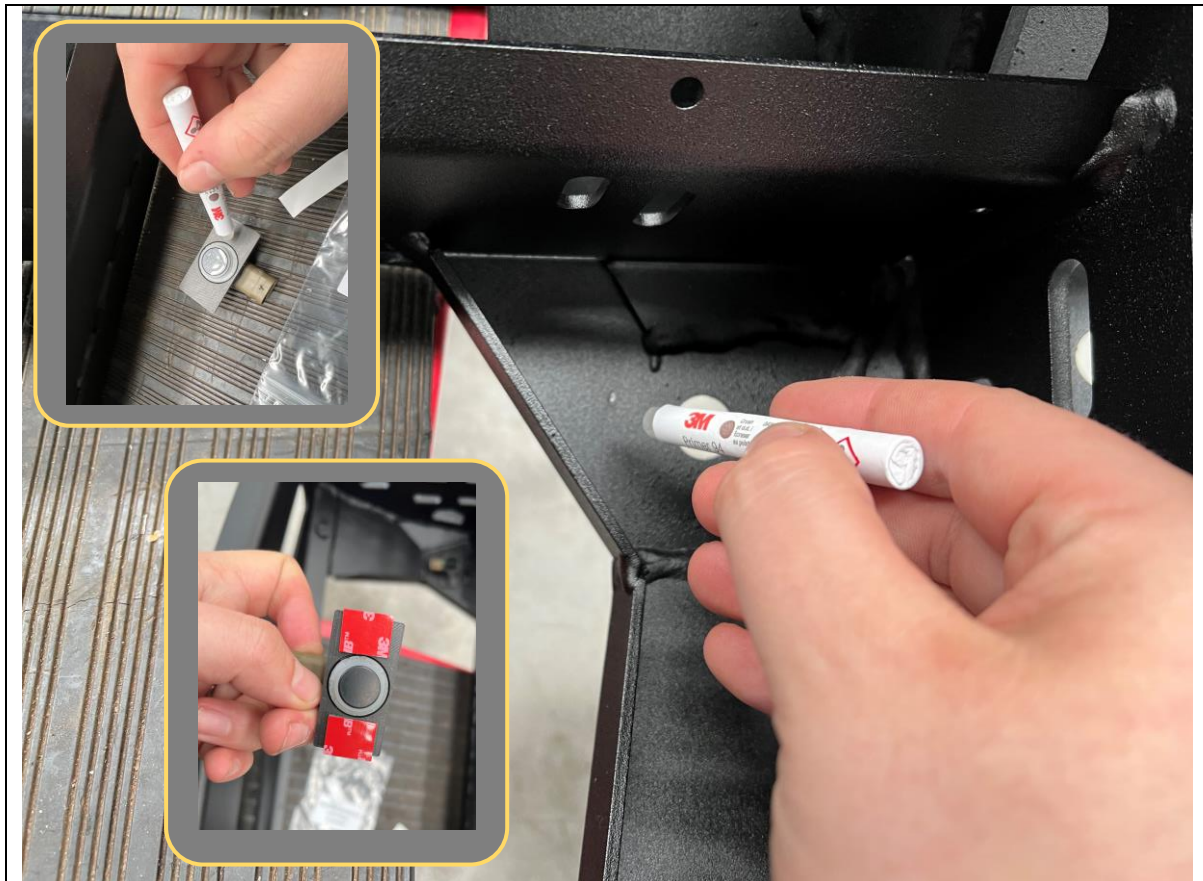

<p>88. If no parking sensors were equipped, insert the supplied round plastic blanking plugs into the holes of the bar.</p> <p>89. Otherwise, clean area surrounding the parking sensor holes in the bar with isopropyl alcohol or similar cleaning solvent and let it dry.</p>	<p><b>TOOLS REQUIRED</b></p> <p>Isopropyl alcohol Rag</p>
<p>90. Apply the 3M Primer 94 adhesion promotor from the tape kit to the parking sensor locations, on both the bar and the supplied plastic sensor holders.</p> <p>91. Apply supplied VHB tape pads to all sensor holders as shown in the inset photo.</p>	<p><b>FASTENERS</b></p> <p>VHB Tape pads Primer 94</p>



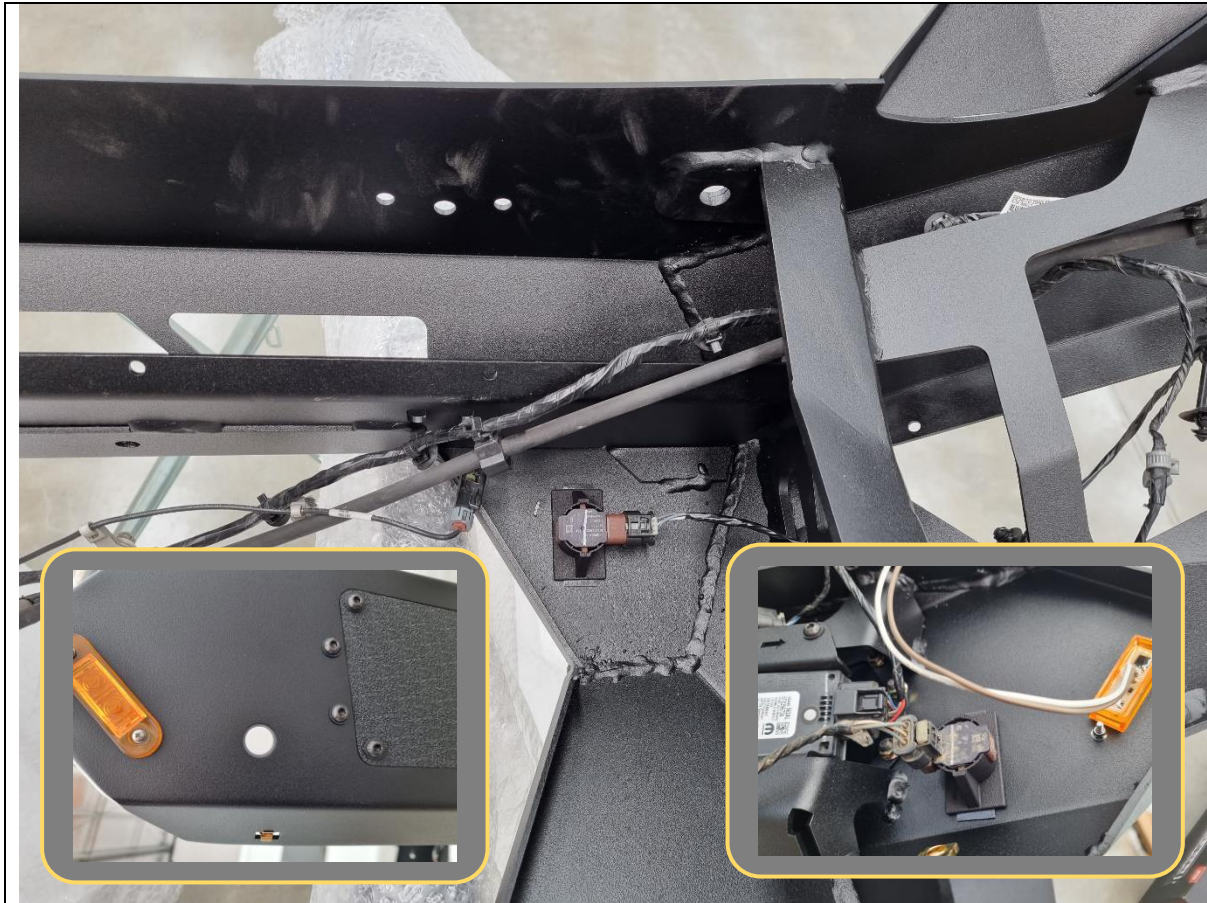

- 92. Dry fit sensors with holders to bar to check loom position is correct. Ensure the same sensor orientation is used as the stock bumper.
- 93. Remove backing and adhere sensors in position in bar. Apply pressure for 20-30sec after positioning for best adhesion.

**TOOLS REQUIRED**

**FASTENERS**



94. The fog lights fitted to Overland and Trailhawk trim levels can be reused in the bar. For all other trim levels, the Offroad Animal 4" Halo Fog Lights may be purchased separately and used.

95. If fog lights can be reused, unbolt them from the bumper using a 7mm socket/spanner.

**TOOLS REQUIRED**

7mm socket/spanner

**FASTENERS**





- 96. Fit fog lights to the fog light brackets with 4x M4x20 pan head screws, flat washers and flange nuts, each.
- 97. The arrow cutout in the bracket indicates the direction the fog light is facing.
- 98. There are two types of fog light brackets supplied – one for the Overland/Trailhawk (main photo) and one for the Offroad Animal 4" Halo fog light (see inset).

**TOOLS REQUIRED**

Phillips head screwdriver  
7mm socket/spanner

**FASTENERS**

8x M4x20 pan head screw  
8x M4 flat washer  
8x M4 flange nut



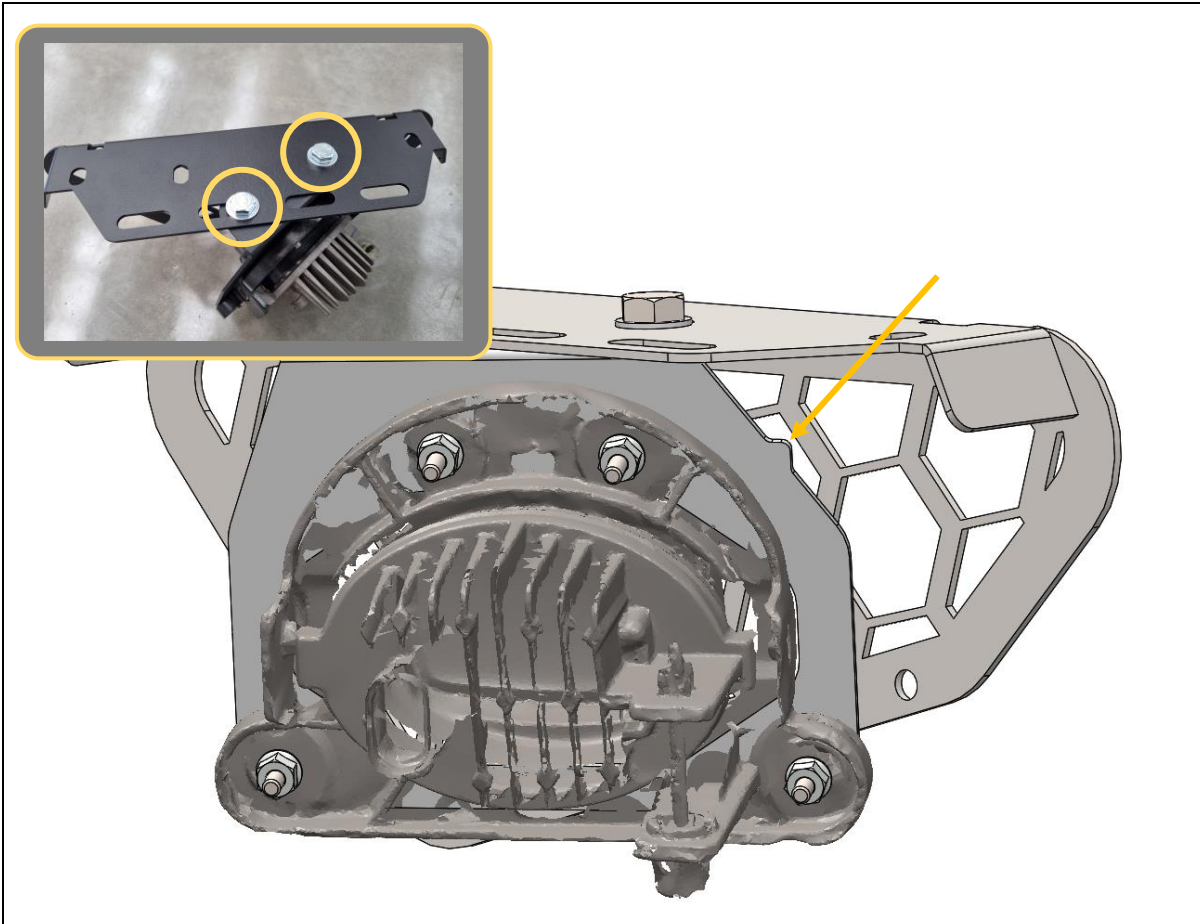

99. Secure the fog light and bracket to the light cover mesh panel, using 2x M8x12 hex head bolts, flat washers and flange nuts.

L/R fog light brackets can be identified by the extra material in the bracket as indicated. Attach in same way as diagram.

100. Do this for both fog lights.

**TOOLS REQUIRED**

13mm socket/spanner

**FASTENERS**

4x M8x12 hex head bolt  
4x M8 flat washer  
4x M8 flange nut



101. Secure the light cover mesh to the bar using 4x M6x16 black button head bolts, black washers and flange nuts.
102. Take care to ensure sensor/radar harnesses are not crushed and are routed neatly. Secure harness to the bar with cable ties (not provided)
103. Do this for both sides.
104. Plug the fog lights back into the main harness.

**TOOLS REQUIRED**

- 4mm hex/Allen key
- Cable ties

**FASTENERS**

- 8x M6x16 black button head
- 8x M6 black flat washer
- 8x M6 flange nut

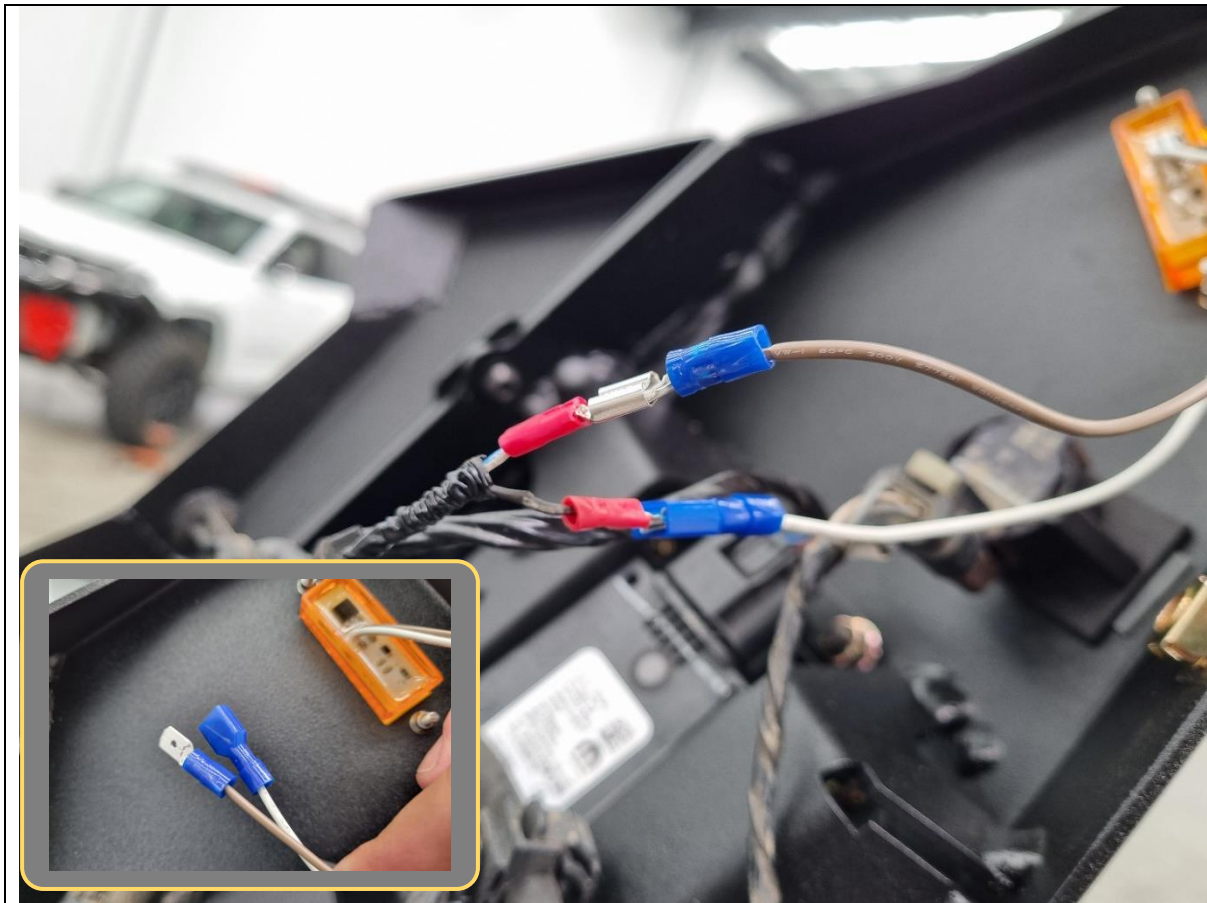

105. Wire up the side marker lamps to the bumper harness.

106. These can be done through soldering, solder splicing or crimp terminal connectors (shown).

107. The wiring pinout for the supplied marker lamp is:  
*Brown = +12V, White = Ground*

The wiring pinout for the factory wiring harness is:  
*White = +12V, Black = Ground*

**TOOLS REQUIRED**

Soldering iron  
or  
Heat gun  
or  
Crimping tool

**FASTENERS**

Soldering wire  
or  
Solder splices  
or  
Crimp connectors





108. If fitting an integrated light bar, do so now.

This bar is designed to fit the Offroad Animal 22-inch light bar. If fitting this light bar, assemble the light bar with legs facing outwards, and line it up with the slots in the centre gusset. Secure with M6 fasteners supplied with the light.

This bar can accommodate most other “20-22inch” size light bars.

109. If fitting driving lights or top hoop to this bar, this is also the most convenient time to do so. It is still possible later but is more difficult.

110. Fit the pan brace to the back of the bar using 5x M6x16 black button head bolts, flat washers and flange nuts.

**TOOLS REQUIRED**

- 4mm hex/Allen key
- 10mm spanner
- Supplied with light bar

**FASTENERS**

- 5x M6x16 black button head
- 5x M6 black flat washer
- 5x M6 flange nut
- Supplied with light bar

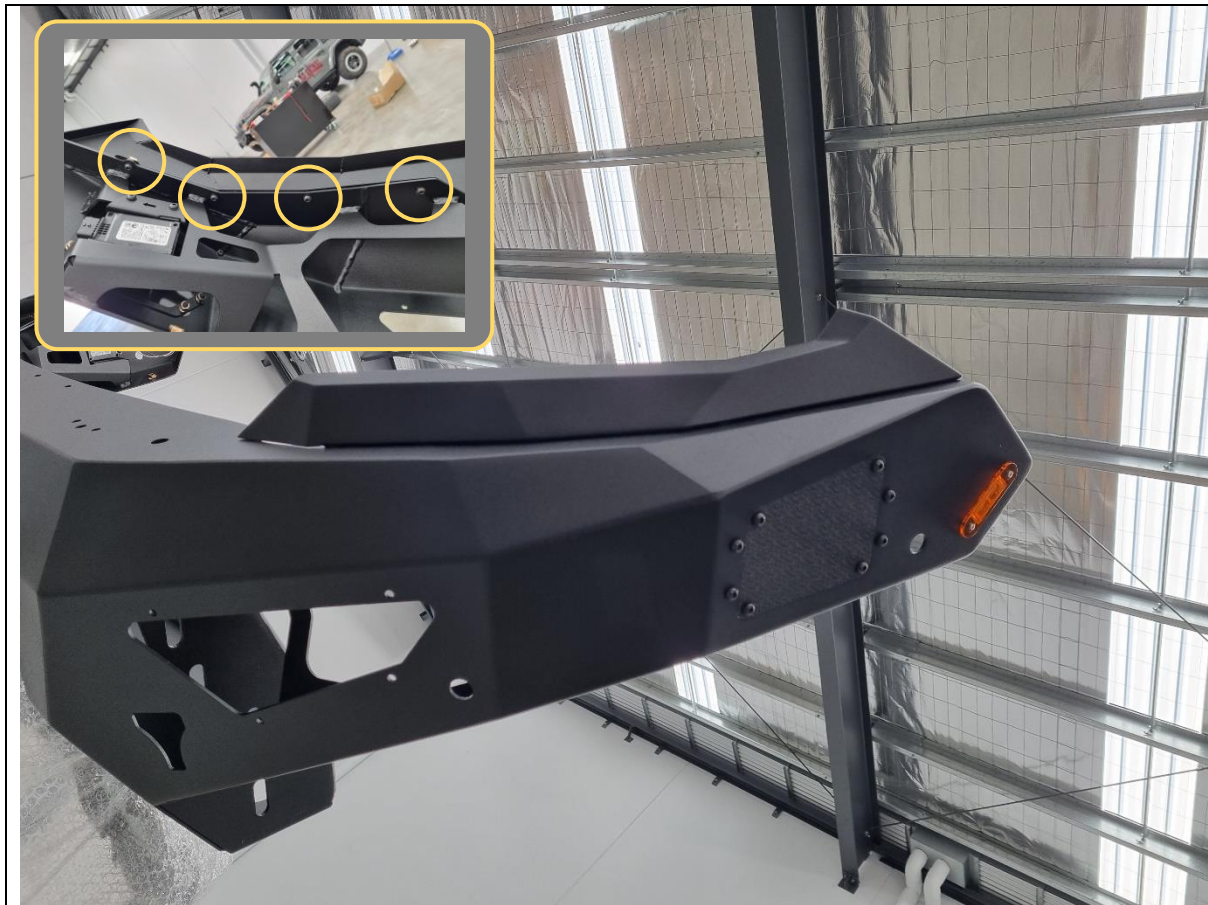

- 111. Fit 4x M6 cage nuts into the slots in the headlight infill, using a flat blade screwdriver to assist.
- 112. Loosely secure the headlight infill to the top of the bar using 4x M6x16 black button head bolts, black washers and flange nuts.
- 113. Repeat for both sides.

**TOOLS REQUIRED**

- Flat blade screwdriver
- 4mm hex/Allen key

**FASTENERS**

- 8x M6x16 black button head
- 8x M6 black flat washer
- 8x M6 cage nut

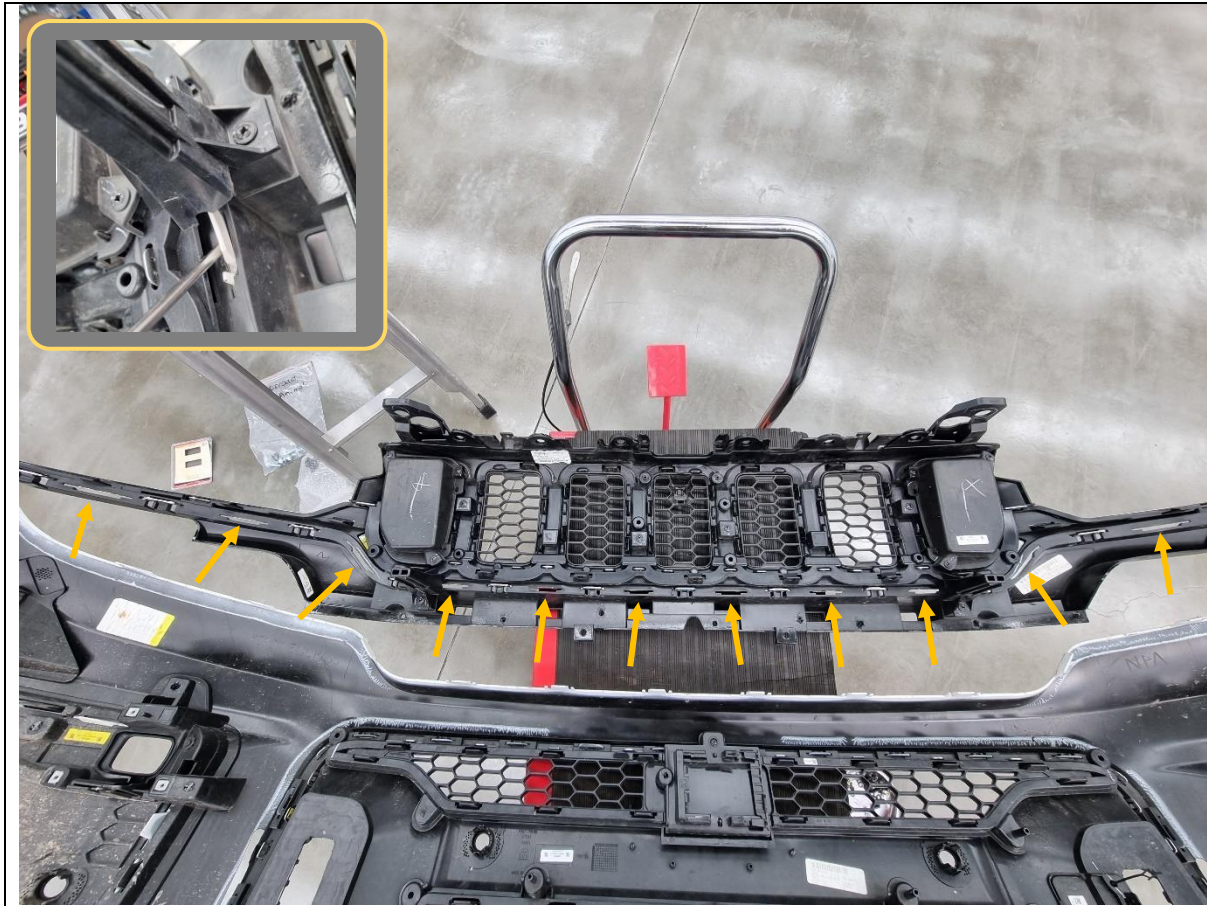

114. Separate the bumper from the grille.

115. There are 12x plastic tabs/clips that can be released with a trim tool or flat blade screwdriver.

**TOOLS REQUIRED**

Trim tool  
or  
Flat blade screwdriver

**FASTENERS**





- 116. Refit the grille to the vehicle and secure using factory retained fasteners. Also refit the radiator grille cover panel.
- 117. Place 1x tape pad (from TK-FB-THL-N80-15 kit) on each corner under each headlight, remove backing and adhere the chrome tips of the grille to the headlight to secure it from flapping around (see inset).

**TOOLS REQUIRED**

- T40 Torx driver
- 10mm socket/spanner

**FASTENERS**

- VHB Tape pads
- 6x T40 Torx screws
- 2x 10mm hex head bolts



- 118. Cut the marked wheel flare an air hacksaw / multi tool / angle grinder / jigsaw.
- 119. Refit the trimmed flares to the vehicle.
- 120. The bar is now ready to be installed onto the vehicle.

**TOOLS REQUIRED**

Air Hacksaw  
or  
Oscillating Multi Tool  
or  
Angle Grinder  
or  
Jigsaw

**FASTENERS**

VHB Tape pads  
  
6x T40 Torx screws  
  
2x 10mm hex head bolts



121. With assistance, either from another person, or a lifting trolley, lift the bar onto the vehicle, with the uprights sliding in between the previously adjusted impact assembly mounts.

122. Secure with 8x M12x30 Bolts, heavy duty washers and M12 Nyloc + flange nuts. Leave finger tight at this stage.

Note: Use a washer on both bolt and nut side for the Nyloc nut. 1x washer on the bolt side is all that is required with flange nuts.

123. Reconnect all sensor and camera looms, as well as washer hoses, to the vehicle.

**TOOLS REQUIRED**

Lifting trolley

**FASTENERS**

8x M12x30 hex bolt  
10x M12 heavy duty washer  
2x M12 Nyloc nut  
6x M12 flange nut



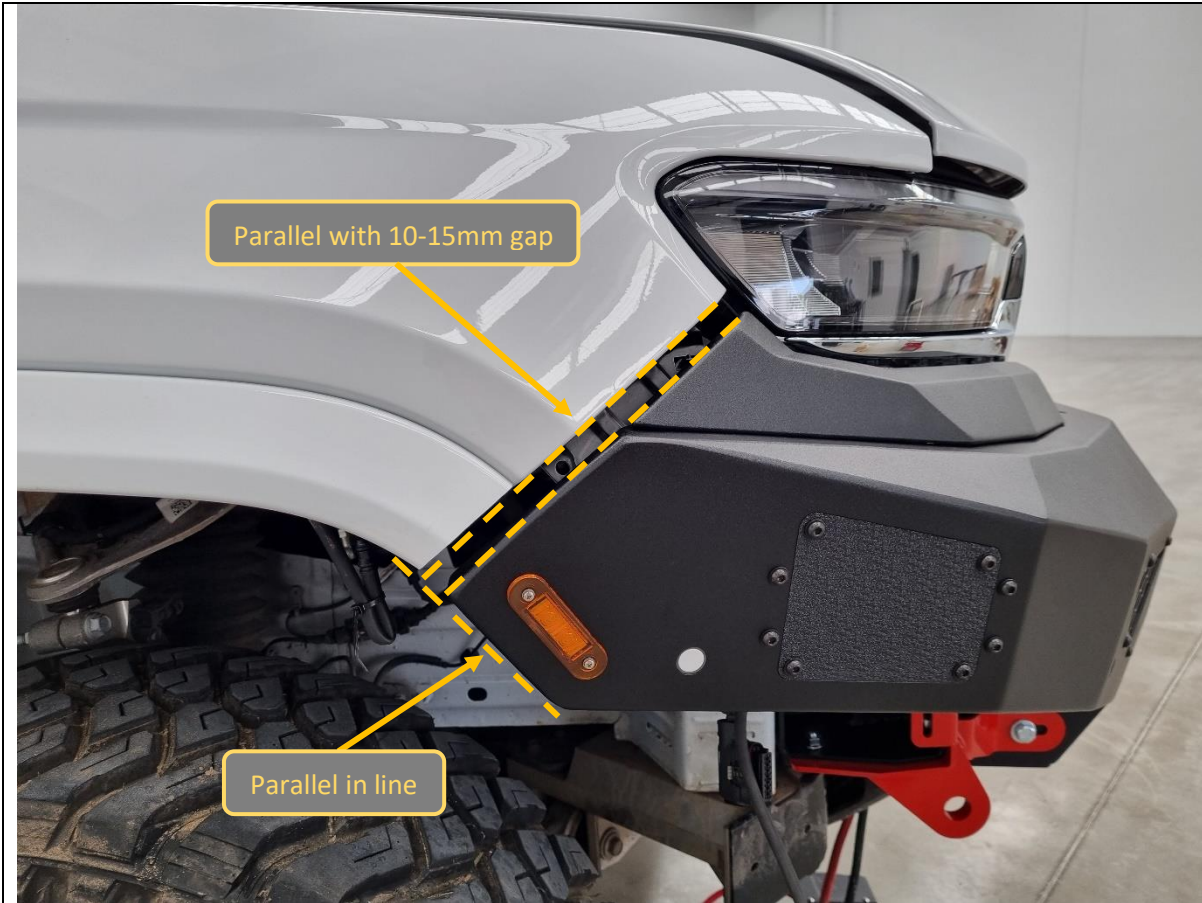

<p>124. With assistance, from another person, align the bar with the edges of the vehicle. The bar should sit symmetric left/right on the vehicle. Also adjust headlight infills if necessary.</p> <p>125. In front view, the top face of the bar should sit in line with the bottom of the grille vents.</p>	<p><b>TOOLS REQUIRED</b></p> <p>18/19mm socket</p> <p>4mm hex/Allen key</p>
<p>126. In side view, the lower face of the bar wing should be in line with the wheel arch, and the upper face should be parallel to the quarter panel (fender) with a 10-15mm gap.</p> <p>127. There must also be approximately 5mm clearance between bar/headlight infills to all parts of the grille to prevent rubbing.</p> <p>128. Once happy with alignment, tighten all 8x M12 bolts and 8x M6 headlight infill bolts from below.</p>	<p><b>FASTENERS</b></p> <p>8x M12x30 hex bolt</p> <p>10x M12 heavy duty washer</p> <p>2x M12 Nyloc nut</p> <p>6x M12 flange nut</p>



<p>129. If fitting a winch, do so now.</p> <p>This bar is designed to fit most low mount winches, in foot down configuration. WARN ZEON 12 is the largest winch confirmed to fit.</p>	<p><b>TOOLS REQUIRED</b></p> <p>Refer to instructions supplied by winch</p>
<p>130. The control box can be mounted on top of the winch, or to the side. Winches usually come with a bracket to allow this. Refer to winch manufacturer.</p> <p>However, due to the radiator active louvres above the cradle, in most cases the winch control box will need to be relocated. A relocation bracket and instructions are found later in this document.</p> <p><u>The available height for winches is 210mm.</u> If your winch and control box is taller, then it will need to be relocated. <u>At least 700mm of cable length is required.</u> Route cabling over the top of the impact assembly to the side where you will be connecting the winch to power.</p> <p>131. Ensure clutch handle will be accessible through opening in front mesh panel. Refer to winch instructions if required.</p>	<p><b>FASTENERS</b></p> <p>Supplied with winch</p>



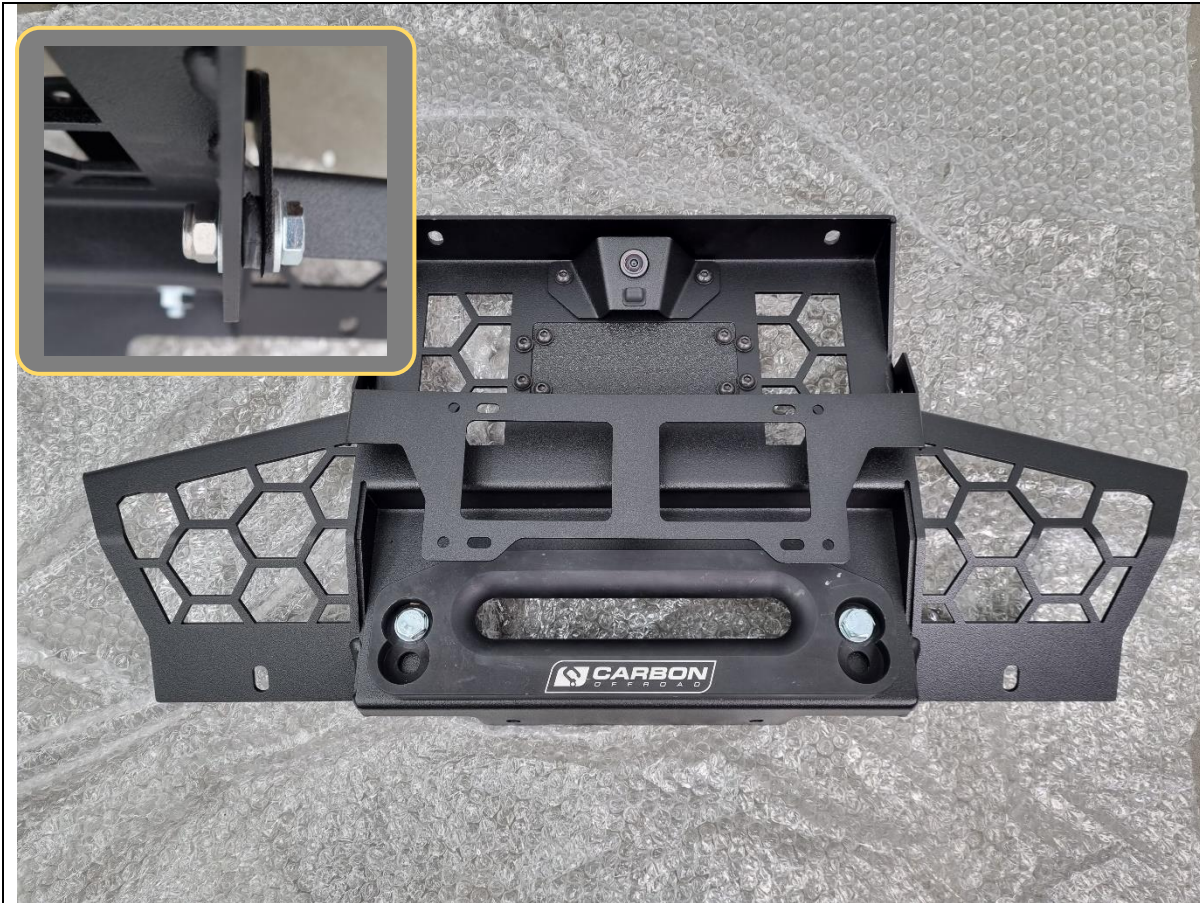

132. If required, fit the winch fairlead to the mesh fairlead mount using M10 or 3/8" fasteners supplied with the winch. This bar is only compatible with hawse type fairleads.

133. Fit number plate flip mount to mesh panel using M8x20 hex bolts, flat washers, nylon washers, and Nyloc nuts.

Note: Nylon washer is inserted in between mesh fairlead and number plate flip mount (see inset).

**TOOLS REQUIRED**

13mm socket/spanner

**FASTENERS**

2x M8x20 hex bolt  
4x M8 flat washer  
2x M8 nylon flat washer  
2x M8 Nyloc nut



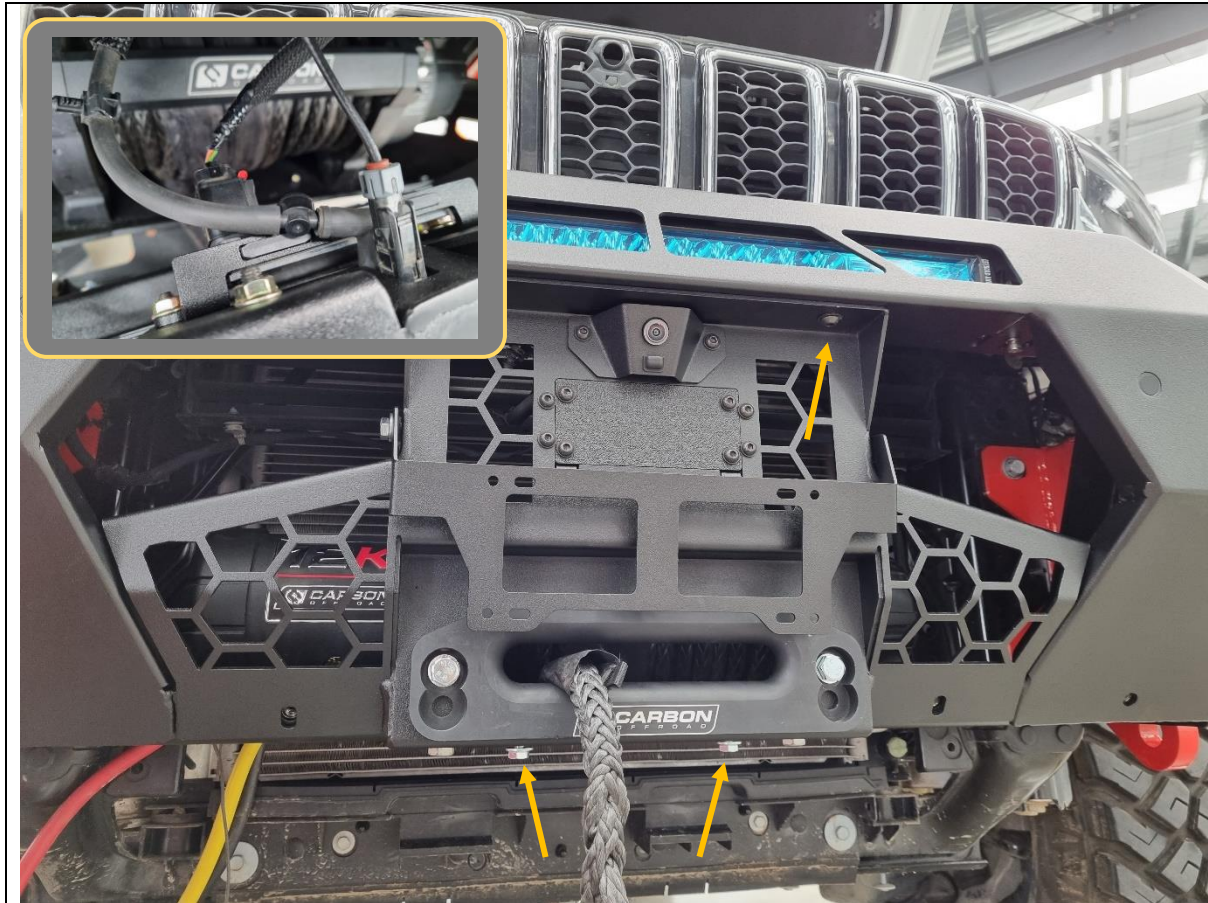

- 134. Fit the mesh fairlead mount to the centre of the bar, using 2x M8x16 black button head bolts (top), 2x M8x20 hex head bolts (bottom) and 4x flat washers.
- 135. Tighten fasteners using 13mm socket/spanner and 5mm hex/Allen key.
- 136. Feed winch cable through the hawse fairlead if applicable.
- 137. Reconnect the camera harness and washer hose if equipped to the back of the mesh fairlead mount (see inset).

**TOOLS REQUIRED**

- 13mm socket/spanner
- 5mm hex/Allen key

**FASTENERS**

- 2x M8x16 black button head
- 2x M8 black flat washer
  
- 2x M8x20 hex head
- 2x M8 flat washer



138. Fit the centre bash plate to the bar using 4x M8x20 black button bolts and flat washers.

**TOOLS REQUIRED**

5mm hex/Allen key

**FASTENERS**

4x M8x20 black button head  
4x M8 black flat washer



139. Secure the bottom of the centre bash plate to the frame using factory 10mm hex head bolts retained from Step 6.

**TOOLS REQUIRED**

10mm hex/Allen key

**FASTENERS**

7x 10mm hex head bolts



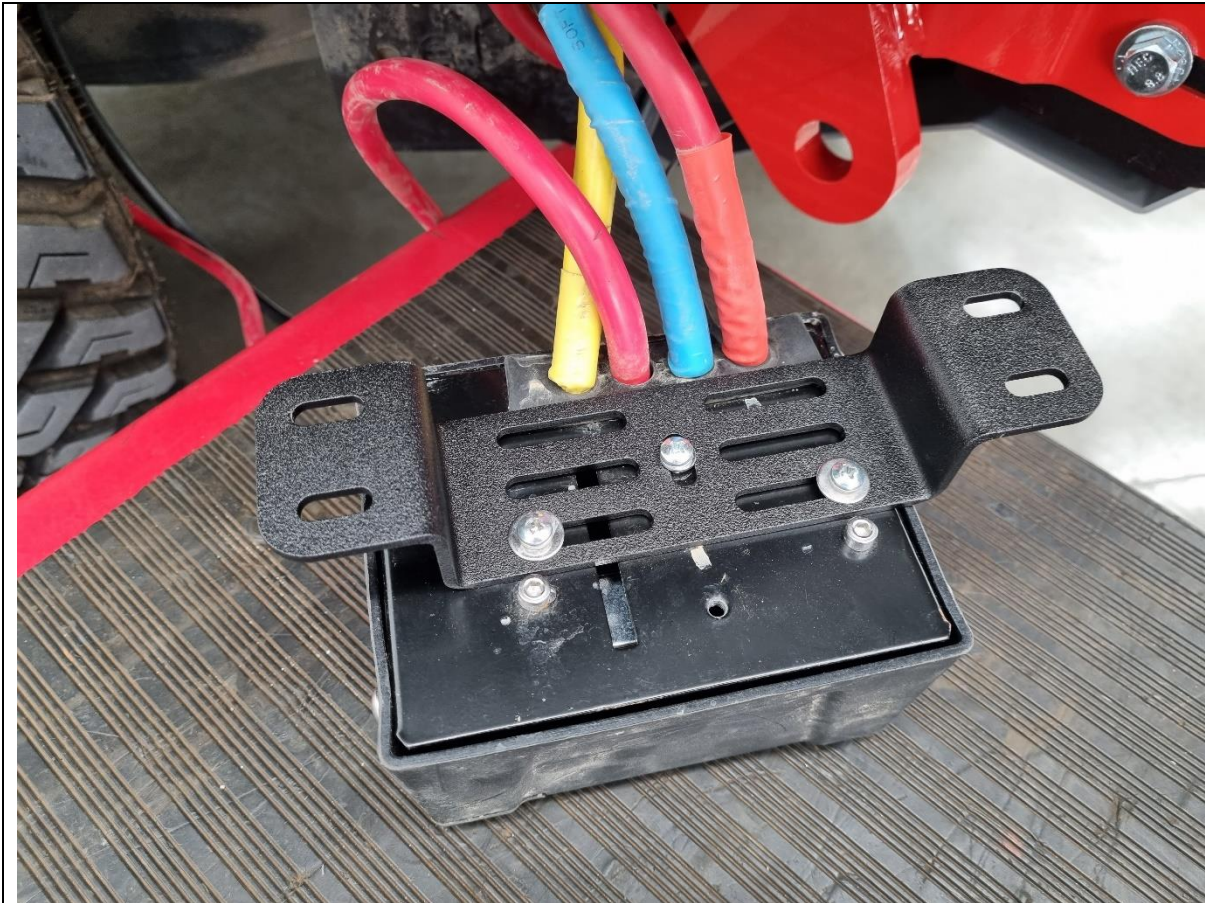

140. If relocating a winch control box, use the supplied relocation bracket and bolt the control box to it (fasteners not supplied).

**TOOLS REQUIRED**

Refer to instructions supplied by winch

**FASTENERS**

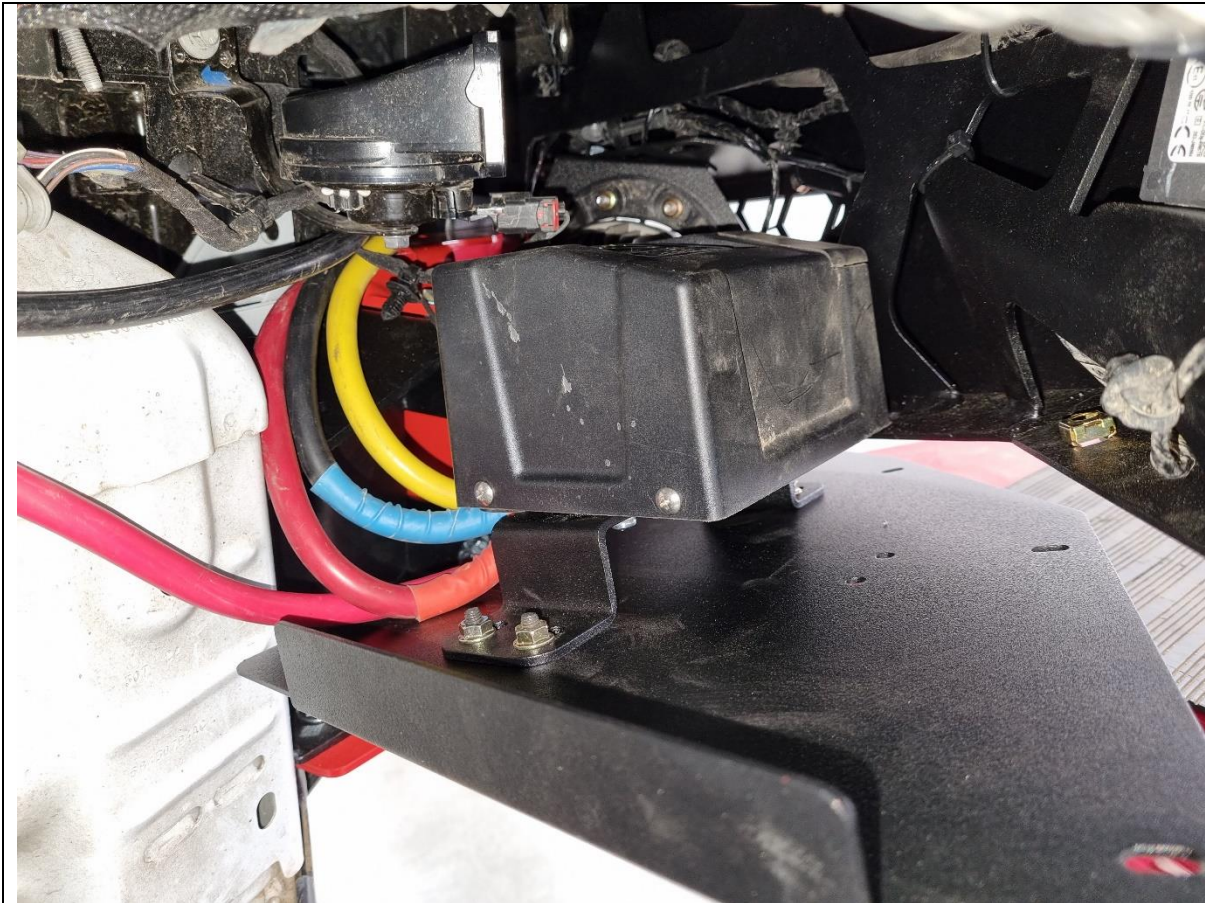

141. Secure the control box and relocation bracket to the inside of the side underpanel with 4x M6x16 black button head bolts, washers and flange nuts.

**TOOLS REQUIRED**

4mm hex/Allen key

**FASTENERS**

4x M6x16 black button head  
4x M6 black flat washer  
5x M6 flange nut



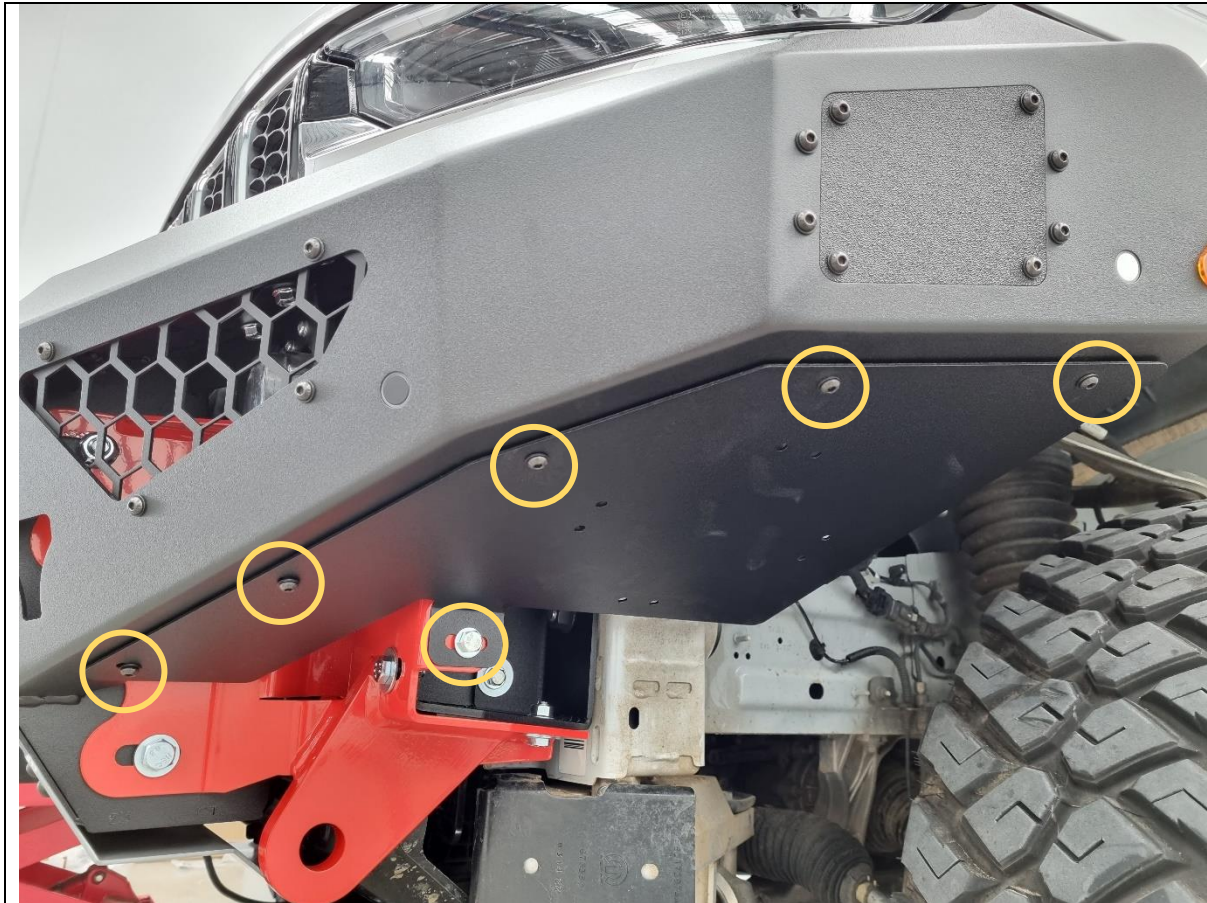

- 142. Loosely fit the side underpanel to the bar with 5x M6x16 black button head bolts and black flat washers.
- 143. Loosely secure the side underpanel to the impact assembly with 1x M8x20 hex bolt, washer and flange nut.
- 144. Repeat for other side underpanel.

**TOOLS REQUIRED**

4mm hex/Allen key  
13mm socket/spanner

**FASTENERS**

10x M6x16 black button head  
10x M6 black flat washer

2x M8x20 hex bolt  
2x M8 flat washer  
2x M8 flange nut





- 145. Refit the wheel arch liner to the vehicle using factory fasteners in reverse order to disassembly.
- 146. Using the edge of the side underpanel as a guide, mark the wheel arch liner, approximately 10mm below the side underpanel.

**TOOLS REQUIRED**

- 8mm socket/spanner  
or  
Phillips Head screwdriver
- 10mm socket/spanner
- 10/11mm metric socket  
or  
13/32" imperial socket

**FASTENERS**



- 147. Cut along the marked line with a utility knife.
- 148. Tuck the wheel arch liner behind the flange of the side underpanel.
- 149. Tighten all side underpanel bolts and repeat for other side.

**TOOLS REQUIRED**

- Utility knife or similar
- 4mm hex/Allen key
- 13mm socket/spanner

**FASTENERS**





<p>150. Fit the Offroad Animal logo plate to the front of the vehicle as shown.</p>	<p><b>TOOLS REQUIRED</b></p> <p>Phillips head screwdriver</p>
<p>151. Fit the compliance plate in a visible location on the underside of the bar. We recommend placing it on the bottom of the centre bash plate.</p> <p>152. Fit the number plate to the flip mount using 2x M5x20 pan head screws, washers and flange nuts.</p> <p>153. Review fitment and double check all bolts are tightened correctly.</p>	<p><b>FASTENERS</b></p> <p>2x M5x20 pan head screw 2x M5 flat washer 2x M5 flange nut</p>





**Congratulations! You're done! Go overlanding and enjoy your newly protected Grand Cherokee.**